

M P AGRO

THE M.P. STATE AGRO INDUSTRIES DEVELOPMENT CORPORATION LIMITED  
PANCHANAN, 3rd FLOOR, MALVIYA NAGAR, BHOPAL  
PHONE - 0755-2551652, 2551756, 2761392 FAX 0755-2557305,  
EMAIL: [mpagrohbpl@gmail.com](mailto:mpagrohbpl@gmail.com) WEBSITE: [www.mpagro.org](http://www.mpagro.org)

# ONLINE RCO DOCUMENT

## FOR SUPPLY OF WATER TANKER MOUNTED ON TWO WHEEL TRACTOR TRAILER - YEAR 2026-27

**DUE ON 07.05.2026**

### RCO DOCUMENT FEES

**Rs. 11000 + 1980 (18%GST) = 12980**

**(Twelve Thousand Nine Hundred Eighty Rs Only) Shall be paid online.**

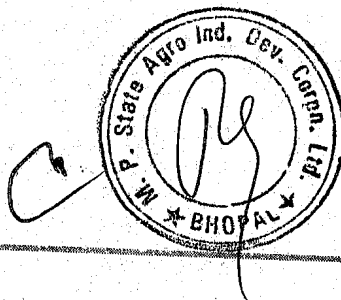



**THE MADHYA PRADESH STATE AGRO INDUSTRIES DEVELOPMENT  
CORPORATION LIMITED**

**"PANCHANAN" 3rd FLOOR, MALVIYA NAGAR, BHOPAL**  
Phone (0755) - 2551652, 2551756, 2551807, Fax: 0755-2557305

**LIST OF ANNEXURE OF RATE CONTRACT BID DOCUMENT**

SN	PARTICULER	ANNEXURE	PAGES NO
1	E - RCO NOTICE	I	03
2	DISCLAIMER & ABBREVIATIONS, DEFINITIONS AND INTERPRETATION	II	04 to 06
3	TITLE, TIME SCHEDULE, RCO FEE & EMD DESCRIPTION OF WATER TANKER	III	07-08
4	ELIGIBILITY OF BIDDER	IV	9-11
5	MANDATORY DOCUMENTS TO BE UPLOADED & TO BE SUBMITTED IN HARD COPIES	V	12
6	APPLICATION FORM	VI	13
7	CONDITIONS OF RATE CONTRACT	VII	14 to 24
8	LETTER OF UNDERTAKING AND DECLARATION	VIII	25
9	FINANCIAL BID FORMAT	IX	26
10	DECLARATION OF BLACKLISTING	X	27
11	DRAFT AGREEMENT	XI	28 to 39
12	FORMATE FOR C.A. CERTIFICATE OF TURNOVER	XII	30
13	FORMATE FOR SIGNING AUTHORITY	XIII	31
14	TECHNICAL SPECIFICATION AND DRAWING DESING	XIV	32-57
TOTAL NO OF PAGES -			57





**THE MADHYA PRADESH STATE AGRO INDUSTRIES DEVELOPMENT CORPORATION LIMITED**  
"PANCHANAN" 3rd FLOOR, MALAVIYA NAGAR, BHOPAL  
Phone (0755)- 2551652, 2551756, 2761392, Fax: 0755-2557305

**ANNEXURE - I**

HO : MKTG/TANKER/2026-27/

Dated:

**E - RCO NOTICE**

Online RCO are invited for supply of FOR SUPPLY OF WATER TANKER MOUNTED ON TWO WHEEL TRACTOR TRAILER FOR THE YEAR 2026-27. Manufacturer of these items may participate in the RCO on the basis of Eligibility Criteria mentioned in the documents.

RCO documents can be purchased by paying RCO fee Rs. 11000 + 1980 (18% GST) = 12980 (Twelve Thousand Nine Hundred Eighty Rs Only) each online up to following date :-

S.N.	Name of Item	Last Date to Submit	EMD
01.	FOR SUPPLY OF WATER TANKER MOUNTED ON TWO WHEEL TRACTOR TRAILER	07.05.2026	2,00,000/-

1- **MSME & STARTUP** Entrepreneurs of Madhya Pradesh are Exempted for EMD. But the Successful Bidder Must have to Submit Rs 200000/- as a Security Deposit at the time of Agreement with Corporation.

2- **MSME and, STARTUP** Belongs Out of Madhya Pradesh Must have to Deposit Rs 200000/- as Earnest Money Deposit Otherwise Their Offer will be Reject.

The detailed RCO and other information can be seen at Corporation's website [www.mpagro.org](http://www.mpagro.org) and [www.mptender.gov.in](http://www.mptender.gov.in). Amendments, if any, will be published only on above websites. No further notification will be made in the newspapers.

**MANAGER (MKTG)**

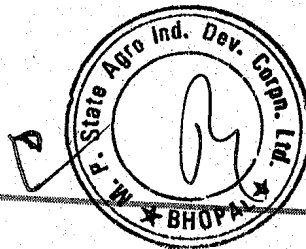



**ANNEXURE - II**

**THE MADHYA PRADESH STATE AGRO INDUSTRIES DEVELOPMENT CORPORATION LIMITED**  
"PANCHANAN" 3rd FLOOR, MALAVIYA NAGAR, BHOPAL  
Phone (0755)- 2551652, 2551756, 2761392, Fax: 0755-2557305

**DISCLAIMER & ABBREVIATIONS, DEFINITIONS AND INTERPRETATION**

**A. DISCLAIMER:**

1. The information contained in this RCO Document has been prepared solely for the purpose of providing information to the interested parties, and is not in any way binding on MP AGRO.
2. By accessing this RCO Document, Prospective Bidder agrees that MP AGRO will not be liable for any direct or indirect loss arising from the use of the information and the material contained in this RCO Document.
3. Prospective Bidder's access to it does not imply a license to reproduce and / or distribute information contained therein and Bidder not allowed to any such act without the prior approval of MP AGRO.
4. In case any Prospective Bidder finds any discrepancy or omission in the any part of the RCO Document/or he has any doubt to their meaning, he should notify the MP AGRO minimum 5 days prior to RCO opening date. MP AGRO may clarify and send instruction to all bidders for correction through portal / Website, if necessary. It however, does not entitle the bidder to seek any extension of RCO opening date.
5. It shall be understood that every endeavor has been made to avoid any error which can materially affect the basis of the RCO and All bidder shall take upon himself and provide for the risk of any error which may subsequently be discovered and shall make no subsequent claim on account thereof.
6. The submission of the RCO will be deemed to imply that the Bidder fully understands the scope of work involved and has read and understood all conditions of the RCO document and his liabilities and responsibilities in respect of the RCO.
7. Information received against any discrepancy (up to due date and time as mentioned above) will be examined and, if any amendments required same will be uploaded as Corrigendum with RCO document. If no amendments are required the Bidder will have no right to raise objection.
8. The Corporation reserves the right to reject any or all of the RCO submitted in response to this RCO at any stage without assigning any reasons whatsoever.
9. The Corporation reserves the right to change any or all of the provisions of this RCO. Such changes would be intimated to prospective bidders on portal.

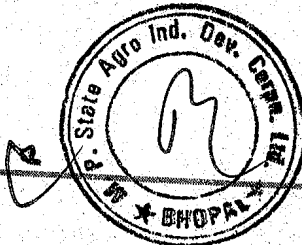

**B. ABBREVIATIONS, DEFINITIONS AND INTERPRETATION**

01. The Corporation/MP AGRO means M.P. State Agro Industries Development Corporation Ltd.
02. Beneficiary/Consignee means The person/department who wish to purchase the items through this Corporation.
03. Application forms/the document means Application forms and all other relevant annexure/documents
04. Applicant/Bidder means The Manufacturer who submits RCO for supply and installation of Items as per document.
05. EMD means Earnest Money Deposit
06. Managing Director means Managing Director of MP State Agro Industries Development Corporation Ltd Bhopal.
07. RCO means - Rate Contract Offer
08. DOH means - Director of Horticulture, Govt. of MP
09. "Contract" means and includes the invitation to RCO, instructions to Bidder, RCO, acceptance of RCO, Conditions to Contract, particulars and the other conditions specified in the acceptance of RCO and includes repeated orders which have been accepted or acted upon by the/ for the Supplier and a formal agreement, if executed;
10. The "Suppliers" means the person, firm or company with whom the order for the supply is placed and shall be deemed to include the suppliers' successors (approved by MP AGRO) representatives, heirs, executors and administrators, as the case may be, unless excluded by the terms of the contract;
11. "The Inspecting Agency" means an Government Agency/Department to Inspect materials or services authorized by QCI approved third party inspection Agency, Govt. Agency such as DGS&D / RITES / CIPET /EIL / IR-Class / PDIL/ Government Engineering College or any Government Technical Department or any Government institution.
12. "The Purchaser" means the MP STATE AGRO INDUSTRIES DEVELOPMENT CORPORATION LIMITED, (MP AGRO).
13. "Materials" means the goods specified in the contract which the Supplier has agreed to supply under the contract;
14. "Test" means such test as is prescribed by the particulars or considered necessary by the MP AGRO performed or made by the inspecting agency acting under an order issued by MP AGRO.
15. Contract shall be governed by the Laws of India for time being in force.

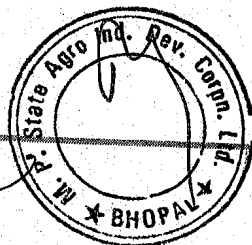

16. Words importing the singular shall include the plural and vice versa, words importing any gender shall include all other genders, words importing persons shall include bodies corporate, unincorporated associations and partnerships and vice versa. References to whole shall include the part and vice versa.
17. The Courts of the place from where the acceptance of the RCO has been issued shall alone have jurisdiction to decide any dispute arising out of or in respect of the contract.
18. A person signing the RCO or any other document in respect of the Contract on behalf of the supplier without disclosing his authority to do so shall be deemed to warrant that he has authority to bind the Supplier. If it is discovered at any time that the person so signing has no authority to do so, MP AGRO may, without prejudice to any other right or remedy of MP AGRO, cancel the contract and make or authorize making of a purchase of the materials at the risk and cost of such person, and hold such person liable to MP AGRO for all costs and damages arising from the cancellation of the contract including any loss which MP AGRO may sustain on account of such purchase.
19. For all purposes of the contract, including arbitration there under, the address of the Supplier mentioned in the RCO shall be address to which all communications addressed to the Supplier shall be sent, unless the Supplier has notified change by a separate letter containing no other communication and sent by registered post acknowledgment due to MP AGRO. The Supplier shall be solely responsible for the consequence of an omission to notify a change of address in the manner aforesaid.

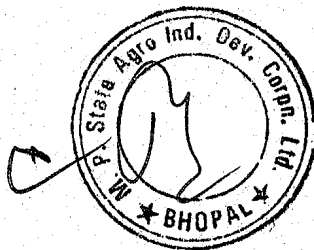



**THE MADHYA PRADESH STATE AGRO INDUSTRIES DEVELOPMENT CORPORATION LIMITED**

"PANCHANAN" 3rd FLOOR, MALAVIYA NAGAR, BHOPAL  
Phone (0755)- 2551652, 2551756, 2761392, Fax: 0755-2557305

**TITLE, TIME SCHEDULE, RCO FEE & EMD, DESCRIPTION**

**(A) TITLE:  
FOR SUPPLY OF WATER TANKER MOUNTED ON TWO  
WHEEL TRACTOR TRAILER FOR YEAR 2026-27.**

**TIME SCHEDULE:**

Stages of Bidding	Scheduled time	Scheduled Date
Purchase of RCO	upto 5.00 PM	07.05.2026
PRE BID MEETING	At 01.00 PM	23.04.2026
Last date of submission	upto 05.00 PM	07.05.2026
Opening of technical bid	upto 01.00 PM	08.05.2026

Financial Bid of the successful bidders will be opened on the date decided by corporation which will be intimated to bidders & published on website in due course of time.

Each stage will take place on the date and time mentioned against them. However if the date and time is changed/ postponed information in this regard will be published on corporation website [www.mptender.gov.in](http://www.mptender.gov.in)

**(B) RCO FEE & EMD:**

The RCO invited under e-RCO system and bidding process will have following steps:

<b>RCO FEE</b>	Rs. 11000 + 1980 (18%GST) = 12980 (Twelve Thousand Nine Hundred Eighty Rs Only) Shall be paid online. (Non Refundable)
<b>EMD</b>	Rs 2,00,000/- (Two Lakh Only) Shall be paid online.
<b>NO EXEMPTATION IS APPLICABLE FOR RCO DOCUMENT FEE</b>	

Note : If RCO is cancelled or RCO of any Bidder is rejected. EMD amount so deposited will be refunded online. No interest shall be paid on EMD amount.



**DESCRIPTION OF WATER TANKER :**

S. N.	ITEM DESCRIPTION
<b>M.S. WATER TANKER</b>	
1.	M.S. WATER TANKER MOUNTED ON TWO WHEEL TRACTOR TRAILER CAPACITY 5000 LITER WITH 900x16 NEW TYRES. <b>MODEL - 1</b>
2.	M.S. WATER TANKER MOUNTED ON TWO WHEEL TRACTOR TRAILER CAPACITY 5000 LITER WITH NEW 900x20 TYRES. <b>MODEL - 2</b>
3.	M.S. WATER TANKER MOUNTED ON TWO WHEEL TRACTOR TRAILER CAPACITY 5500 LITER WITH 900x16 NEW TYRES. <b>MODEL - 3</b>
4.	M.S. WATER TANKER MOUNTED ON TWO WHEEL TRACTOR TRAILER CAPACITY 5500 LITER WITH 900x20 NEW TYRES. <b>MODEL - 4</b>
5.	M.S. WATER TANKER MOUNTED ON TWO WHEEL TRACTOR TRAILER CAPACITY 5000 LITER WITH FIRE FIGHTING PUMP AND 900x16 NEW TYRES. <b>MODEL - 5</b>
6.	M.S. WATER TANKER MOUNTED ON TWO WHEEL TRACTOR TRAILER CAPACITY 5000 LITER WITH FIRE FIGHTING PUMP AND 900x20 NEW TYRES. <b>MODEL - 6</b>
<b>G.I. WATER TANKER</b>	
7.	G.I. WATER TANKER MOUNTED ON TWO WHEEL TRACTOR TRAILER CAPACITY 5000 LITER WITH 900x16 NEW TYRES. <b>MODEL - 7</b>
8.	G.I. WATER TANKER MOUNTED ON TWO WHEEL TRACTOR TRAILER CAPACITY 5000 LITER WITH NEW 900x20 TYRES. <b>MODEL - 8</b>
9.	G.I. WATER TANKER MOUNTED ON TWO WHEEL TRACTOR TRAILER CAPACITY 5500 LITER WITH 900x16 NEW TYRES. <b>MODEL - 9</b>
10.	G.I. WATER TANKER MOUNTED ON TWO WHEEL TRACTOR TRAILER CAPACITY 5500 LITER WITH 900x20 NEW TYRES. <b>MODEL - 10</b>
11.	G.I. WATER TANKER MOUNTED ON TWO WHEEL TRACTOR TRAILER CAPACITY 5000 LITER WITH FIRE FIGHTING PUMP AND 900x16 NEW TYRES. <b>MODEL - 11</b>
12.	G.I. WATER TANKER MOUNTED ON TWO WHEEL TRACTOR TRAILER CAPACITY 5000 LITER WITH FIRE FIGHTING PUMP AND 900x20 NEW TYRES. <b>MODEL - 12</b>

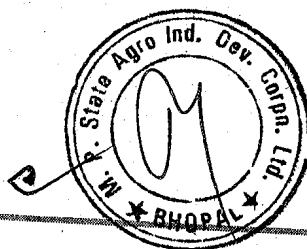



**THE MADHYA PRADESH STATE AGRO INDUSTRIES DEVELOPMENT CORPORATION LIMITED**

"PANCHANAN" 3rd FLOOR, MALAVIYA NAGAR, BHOPAL  
Phone (0755)- 2551652, 2551756, 2761392, Fax: 0755-2557305

**ANNEXURE - IV**

**ELIGIBILITY OF BIDDER**

**(A) ELIGIBILITY :**

S.N.	ELIGIBILITY	DOCUMENT TO BE UPLOADED
1	RCO documents (Page 1 to 57)	RCO documents duly signed on each page with office seal affixed.
2	Bidder should be manufacturer for the RCO item.	Certificate from Industry department / District Industrial Center (DIC)/ Single Point Registration Certificate of NSIC/UDYAM Registration Certificate issued by Ministry of Micro Medium & Small Enterprises .
3	Bidder should have valid feasibility Report.	Valid feasibility report for manufacturing of RCO items by any Government Agency which approved by Constitutional Board of QUALITY COUNCIL OF INDIA i.e. NATIONAL ACCREDITATION BOARD FOR CERTIFICATION BODIES ( N.A.B.C.B) or any Government Engineering College or any Government Technical Department or Government institutions i.e. Govt. Polytechnic Collage, Govt.ITI, MSME Training Centre , ETC. <b>Feasibility report must covered the following points</b> (A) Name and full address of Manufacturing unit. (B) Machineries Installed in Manufacturing unit Name and Quantity. (C).Production Capacity of Manufacturing unit for RCO Items. (D) Manufacturing unit is in running condition or not. <b>Note - Feasibility Report Issued by any Private Agency will not be Accepted</b>
4	Bidder should have approved Drawing Design of RCO items	Drawing Design approved by State Transport commissioner.
5	Bidder should have Valid Trade Certificate	Valid Trade certificate Issued by Concerned District Transport Authority.

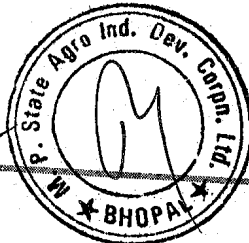

S.N.	ELIGIBILITY	DOCUMENT TO BE UPLOADED
6	The Total Cumulative Turnover of the Bidder for the Last Three financial Years i.e. (2022-23, 2023-24 and 2024-25) in Fabrication Items should not less than be 4 (Four ) crorer.  1- Startup and MSME of M.P. will get Relaxation of Rs/- 2 corer .	A certificate issued by Chartered Accountant with UDIN Number showing Turnover for the last three financial years, i.e. (2022-23, 2023-24 and 2024-25).
7	Other necessary requirements for eligibility shall be as mentioned in Rate Contract BID document	<ul style="list-style-type: none"> <li>• Application form duly filled as par <b>Annex - VI</b></li> <li>• Valid proof of authority to signing the document in case of Partnership Firm and Limited Firm</li> <li>• GST Registration certificate</li> <li>• Affidavit from the Bidder that their firm is presently not blacklisted by any Govt. organization, semi Govt. organization or any corporation till date <b>Anex - X</b></li> <li>• Letter of Undertaking &amp; Declaration on 500 Rs Stamp Paper <b>Anex - VIII</b></li> <li>• Scheduled Castes, Scheduled Tribes, Women owned entrepreneurs are required to submit evidence online in support of eligibility.</li> </ul>

(A) **PROVISION FOR SCHEDULED CASTE/TRIBE AND WOMEN ENTREPRENEURS** :According to the policy of the state government, SC/ST offerers, who will be presented with a certificate related to special registration in the District Industry Center NSIC/UDYAM Registration Certificate who will be found eligible as per the online rate contract offer conditions, will be given opportunity of minimum 25% of the business (as per clause 23.4 of prescribed policy, M.P. Dated 13 /01/2023), out of which, 4 percent participation will be ensured in the business. Similarly, according to Clause 23.1(1) of the Store Purchase Rule, out of minimum 25 percent participation of 3 percent in the business, it will be ensured to purchase from micro and small enterprises owned by women. To get the above facility/priority, it is mandatory to submit self-attested copies of related documents along with RCO. This system will be valid only in those cases where firm orders are received from the government. In case of purchase by the farmer, the farmer will have full right to choose.

(B) **Provision to the Startup** . According to the provisions of rule 14.1 of the Madhya Pradesh Store Purchase, 2015 (as amended in 2022), the qualified M.P. Startup offerer exempted for Earnest money Deposit (EMD), and rule 22(1) qualified Startup offerer may be exempted experience and turnover. To get the above facility it is mandatory to submit self-attested copy of Startup Certificate issued by Department of Industrial Policy and Promotion (DIPP) under the Ministry of Commerce and Industry along with RCO.  
**Startup of M.P. Exempted for Earnest money Deposit (EMD), and will be given Relaxation of Rs/- 2 Crore in Turnover .**

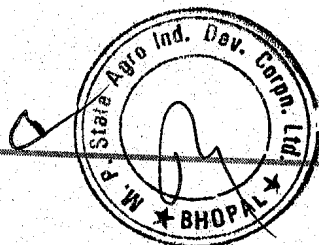

(C) **Provision for MSME**

According to the provisions of rule 14.1 of the Madhya Pradesh Store Purchase, 2015 (as amended in 2022), the qualified MSME of M.P. offerer exempted for Earnest money Deposit (EMD) only, To get the above facility it is mandatory to submit self-attested copy of Udyam Registration Certificate issued by Ministry of Micro, Small and Medium Enterprises along with RCO.

**MSME of M.P. Exempted for Earnest money Deposit (EMD) and will be given Relaxation of Rs/- 2 Crore in Turnover .**

(D) **NON-ELIGIBILITY TO PARTICIPATE IN THE RCO DUE TO PENDING COURT CASE/DISPUTE**

The offers of such bidders shall not be accepted with whom any court case and/or dispute are pending with the Corporation, other Government department or any other organization/agency. Offers of such bidders shall also not be accepted with whom any criminal case is also pending. **if the offerer has any Serious Dispute with the Corporation or Black listed by the Corporation regarding the supply of any other material or any other RCO then the same will be considered against the offerer for this RCO.**

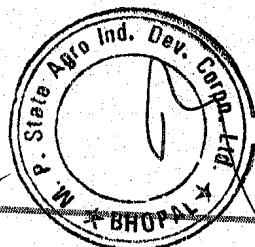



**THE MADHYA PRADESH STATE AGRO INDUSTRIES  
DEVELOPMENT CORPORATION LIMITED**

"PANCHANAN" 3rd FLOOR, MALAVIYA NAGAR, BHOPAL  
Phone (0755)- 2551652, 2551756, 2761392, Fax: 0755-  
2557305

**ANNEXURE - V**

**MANDATORY DOCUMENTS TO BE UPLOADED :**

01. RCO documents duly signed on each page with office seal affixed.  
(Page 1 to 59)
  02. Certificate from Industry department / District Industrial Center (DIC)/ Single Point Registration Certificate of NSIC/UDYAM Registration Certificate issued by Ministry of Micro Medium & Small Enterprises .
  03. Valid feasibility report for manufacturing of RCO items by any Government Agency which approved by Constitutional Board of QUALITY COUNCIL OF INDIA, NATIONAL ACCREDITATION BOARD FOR CERTIFICATION BODIES ( N.A.B.C.B) or any Government Engineering College or any Government Technical Department or Government institutions i.e. Govt. Polytechnic Collage, Govt. ITI, MSME Training Centre, ETC.  
**Feasibility report must covered the following points**
    - (A) Name and full address of Manufacturing unit.
    - (B) Machineries Installed in Manufacturing unit Name and Quantity.
    - (C) Production Capacity of Manufacturing unit for RCO Items.
    - (D) Manufacturing unit is in running condition or not.
- Note - Feasibility Report Issued by any Private Agency will not be Accepted**
04. Approved Drawing Design approved by State Transport commissioner.
  05. Valid Trade certificate Issued by Concerned District Transport Authority.
  06. A certificate issued by Chartered Accountant with UDIN Number showing Turnover for the last three financial years, i.e. ( 2022-23, 2023-24 and 2024-25) in supply of Fabrication Items .
  07. Application form duly filled as par **Annexure - VI**
  08. Valid proof of authority to signing the document in case of Partnership Firm and Limited company.
  09. GST Registration certificate.
  10. Affidavit from the Bidder that their firm is presently not blacklisted by any Govt. organization, semi Govt. organization or any corporation till date. **Annexure-X**
  11. Letter of Undertaking & Declaration on 500 Rs Stamp **Annexure - VIII**
  12. Financial Bid as per schedule **Annexure - IX**
  13. Electricity Bills for last three months
  14. Scheduled Castes, Scheduled Tribes, Women owned entrepreneurs are required to submit evidence online in support of eligibility.

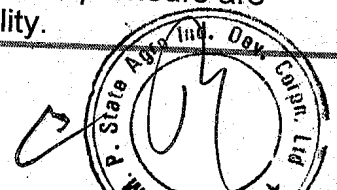

To

Managing Director  
M P State agro Industries Development  
Corporation Ltd 3rd Floor, Panchanan Bhawan  
Malviya Nagar  
Bhopal

## APPLICATION FORM

ANNEXURE - VI

**Sub :-** RCO Document for supply of FOR SUPPLY OF TWO WHEEL WATER TANKER  
FOR THE YEAR 2026-27 & ONWARD.

Dear Sir,

Kindly accept our application for RCO Document for supply of WATER TANKER MOUNTED ON  
TWO WHEEL TRACTOR TRAILER FOR THE YEAR 2026-27.in the state of Madhya Pradesh.  
I am submitting application and details as under.

1	Name & Address of the Applicant Firm			
	<b>If Proprietorship</b>			
	a) Name of Proprietor			
	b) Full Address			
	c) PAN number /GSTN No			
	d) E - Mail			
	<b>If Partnership</b>			
	a) Name of partners and their address	1.	2.	3.
	b) Is partnership deed registered If yes then date of registration (attach copy of deed)	Yes / No		
	c) E - Mail	Date .....		
	<b>If Limited or Pvt. Limited Company under Indian Companies Act 1956.</b>			
	Limited or Private Limited			
	Registered Office Address			
	Date of Certificate of in Corporation			
	E - Mail			
2	<b>IF LLP</b>			
	a) Name & Address of Partners			
	b) Certificate of registration			
	c) E - Mail			
3	Location of Production units			
4	Year of Establishment of the units.			
5	Name, Designation & Mobile Number of Contact Person,			
6.	Name of Person Singing the RCO (In Case Of Authorized Person Specific Power of Attorney has to be submitted)			
7	Details of Turnover for last Three financial years ( Rs in Lakhs )	Year	Turn Over	
		2022-23		
		2023-24		
		2024-25		

I here by confirm that all the above information is true to the best of my  
knowledge & belief. All the documents as required in the documents as enclose.  
Date .....

**Note:** Separate sheet may be used if necessary. Strike out whatever not applicable.

Seal & Signature

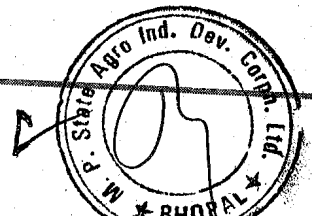



**THE MADHYA PRADESH STATE AGRO INDUSTRIES DEVELOPMENT CORPORATION LIMITED**

"PANCHANAN" 3rd FLOOR, MALAVIYA NAGAR, BHOPAL  
Phone (0755)- 2551652, 2551756, 2761392, Fax: 0755-2557305

**ANNEXURE - VII**

**CONDITIONS OF RATE CONTRACT**

**1. PROCEDURE FOR RCO:**

- 1.1 The Corporation invites online RCO for supply and installation of Material mentioned in Annexure - III.
- 1.2 Only one online RCO will be accepted from One Applicant / Firm. If any individual participating in the BID, representing more than one firm in one or different names and it comes to MP AGRO'S knowledge at any point of time, all such BID will not be entertained and shall be liable for rejection.
- 1.3 The bidders intending to participate in this RCO are required to get enrolled/registered on the [www.mptender.gov.in](http://www.mptender.gov.in). Enrolment / registration and subsequent empanelment on the above portal and sub portal is mandatory.
- 1.4 RCO documents can be purchased only online from <http://mptender.gov.in> by making online payment of portal fees etc.
- 1.5 It is the discretion of the Managing Director of the corporation to accept/reject the application without assigning any reason thereof.

**2. SUBMISSION OF RCO:**

Corporation Invites online RCO for supply of material as mentioned in (Annexure III). The Bidder will have to get themselves registered with [www.mptender.gov.in](http://www.mptender.gov.in) for E-tendering, without registration BID cannot be uploaded on portal. To participate in Online RCO interested Bidder will be required Registration at Portal and valid class 3 digital signature certificates. An amount of Rs 12980/- as RCO fees to be deposited online through website [www.mptender.gov.in](http://www.mptender.gov.in) that is to be paid by Bidder for registration under E-tendering.

**3. OPENING OF TECHNICAL BID:**

Soft copies uploaded upto due date and time will be opened on due date and time as mentioned in (Annexure III)

**4. DELAY IN SUBMISSION:**

The Corporation will not be responsible for any delay on any account in receipt of RCO. If the BID is received after the specific date and time, even if the delay in receipt was caused in postal transit or any other reason, what so ever.

**5. CHANGE IN OPENING SCHEDULE:**

RCO will be opened on due date and time as mentioned in (Annexure-III) point B in the presence of the representative of firms who wishes to be present. However if the date and time of opening of Technical Bid is changed due to any unforeseen reason the revised date and time of opening will be displayed on Portal/website of the corporation. No corrigendum will be issued through News Papers.

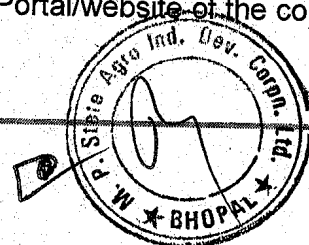

6. **MODUS OPERANDI FOR THE PURCHASE & SALES OF THE ITEMS & QUOTING RATES BY BIDDER:**

- (i) MP AGRO will buy material for onward sale to various Govt. Deptt. as per demand/requirement.
- (ii) Bidders are required to quote their Basic selling rate without GST to MP AGRO with the intention that MP AGRO will load GST and its own margin (5% + GST on margin) to the prices quoted by Bidders.
- (iii) Bidders are required to upload their rates in the format prescribed for it. Shown in the financial Bid.
- (iv) Rate list to be uploaded will be Basic rates without GST. The GST, MP AGRO margin & GST their on not to be included in this format.
- (v) Rates offered to MP AGRO should not be treated as rates to end user. Instead MP AGRO will work as dealer of the manufacturer. Manufacturer will be free to appoint their Sales Representative, other Dealer for after sales service & stocking purposes etc. Manufacturer can also incur expenses for sales promotion etc. as per their own policy.
- (vi) On the several occasions manufacturers do not quote lower rate to MP AGRO due to Price fall Clause executed by them with other organization. Difference between price quoted to MP AGRO & price quoted to other organization (for ultimate consumer) must be differentiated clearly that rate quoted to MP AGRO is the dealer rate.
- (vii) MP AGRO will be at full liberty to reduce or increase its margin at any time without consent from bidder. Managing Director Decision will be final & binding for all parties.
- (viii) The bidder should quote their lowest price, in accordance to the prevailing rates of the company to their other authorized dealer etc. Dealer rate may be decided by the company at its own on the basis of "Dealer Rate" prevailing for others dealer in Madhya Pradesh.
- (ix) M.P. Agro would like to execute agreements with all other eligible participants whose offer rates are within the limit of L-1+15% on the lowest rates, if they wish to do so.

7. **ACCEPTANCE OF OFFER FOR RATE CONTRACT:**

The Counter offer will be issued by the Corporation only to those offerers whose offer rates are within the limit of L-1+15%.

8. **EXECUTION OF AGREEMENT :**

- (a) The Corporation will intimate the successful L-1 Bidder regarding acceptance and request him to execute the agreement in given time limit. In case the L-1 Bidder fails to execute agreement within the prescribed time limit, the EMD submitted along with the RCO shall stand forfeited and their firm will be Black listed for 1 year of above RCO.
- (b) The successful Bidder shall have to execute an agreement as per **Annexure-XI** with the Corporation on non-judicial stamp paper of Rs. 1000/- (to be purchase by the Bidder)

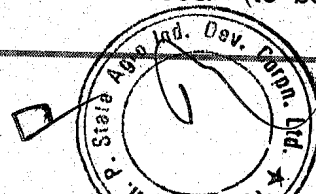

**9. EARNEST MONEY DEPOSIT:**

**MSME & STARTUP Entrepreneurs of Madhya Pradesh** are Exempted for EMD. But the Successful Bidder Must have to Submit Rs 200000/- as a Security Deposit at the time of Agreement with Corporation.

**MSME and, STARTUP Belongs Out of Madhya Pradesh** Must have to Deposit Rs 200000/- as Earnest Money Deposit through online Portal Otherwise Their Offer will be Reject.

- A.**
- (i) RCO should accompany EMD as per clause B (**Annexure-III**)
  - (ii) Earnest Money of all unsuccessful Bidders will be returned.
  - (iii) No interest is payable on the amount of Earnest Money at the time of refund.

**B. Earnest Money shall be forfeited if :-**

- (i) Deposit (EMD) is liable to be forfeited if the bidder withdraws or amends or impairs or derogates from the bid in any respect within the validity of the bid or is open for acceptance whether originally fixed or extended.
- (ii) No interest shall be payable by the Purchaser on the Earnest Money/Bid Guarantee to the Bidder.
- (iii) The Earnest Money shall remain deposited with the Purchaser during the validity period as mentioned, from the date of opening of RCO. If the validity of the offer is extended, EMD validity period deemed extended.
- (iv) Earnest money of successful Bidder belongs out of MP will be adjusted as Security Deposit (SD) on execution of the agreement. (such Bidder will become supplier).

**10. SECURITY DEPOSIT:**

- (i) The SD will remain with the corporation during the currency of the contract and till successful execution of all the order placed during the currency of the contract and will be refunded to the supplier without interest in case of no dispute and after getting clearance/NOC from District Managers of the Corporation /purchasing officer.
- (ii) Security deposit will be forfeited in case of failure of supply of the material as mentioned in the purchase order, in time and as per the approved specifications, or for any breach of terms and condition of the agreement and RCO document.

**11. MINIMUM TECHNICAL SPECIFICATIONS OF ITEMS**

Minimum Technical specifications of the items covered in this RCO are the same as they are defined in (**Annexure - III**).

**12. PLACEMENT OF ORDER**

Head Office / Regional Manager / Branch Manager of the Corporation shall place purchase order to the approved supplier.

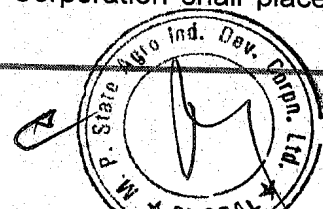

### 13. SCHEDULE AND MODE OF SUPPLY / DELIVERY

The Bidder has to supply and deliver the ordered quantity within time period as mentioned in the Administrative Sanction issued by the District Collector/supply order issued by Buyer's or the order issued by the Regional Manager/HO of the Corporation Failure of the Supplier for timely supply, or NON Supply of the material shall lead to forfeiture of Security Deposit and the RCO shall stand cancelled and agreement shall be terminated and Supplier shall be black listed/ debarred from supplies through the corporation for 1-5 years. Corporation can also claim loss of good will as deemed fit and the same shall be payable by the Bidder. MP Agro shall not be liable toward the first manufacturer. In case the manufacturer is unable to supply or refuses to supply the RCO Material as per the work order issued by MP Agro, then in such a case the Work order may be Cancelled and the material can be procured from any other Registered vender and difference amount if any may also be recovered from the original Vendor.

- (a) If the indenting authority suffers any loss due to inordinate delay in effecting supply/ dispatch or arrival of the material at the destination, the same shall be the responsibility of the Bidder who shall make good the entire loss suffered by the indenting authority. The Managing Director will assess and intimate the Bidder the extent of loss, and the same will be acceptable to the Bidder. The supplier shall ensure that the ordered material being supplied by him reach the consignee at destination in good condition. As such it will be the sole responsibility of the supplier to ensure desired quality and standard of the material.
- (b) The ordered item as specified in order shall be in conformity with approved size and quality specifications mentioned in **Annexure-IV**, of the RCO and elsewhere in the RCO documents. Material shall be supplied in batches in any or all the sizes and in quantities as per delivery schedule ordered by the ordering authority of the Corporation. The delivery schedule may however be revised by the ordering authority, if warranted by exigency of the work of the Corporation. The successful Bidder shall be bound to effect deliveries in accordance with the changed supply schedule without claiming revision in rates. The dates of supply shall be the date on which the consignment reaches the required destination.
- (c) Ordered item may required to be supplied to the consignee through District Manager office of the corporation as per dispatch order to be given by the Regional Manager of the Corporation, securely packed so as to withstand rough handling and protection from vagaries of nature during transit.
- (d) Relevant Delivery Challan shall be sent free and direct to the consignee (s) freight paid. The order No. of Corporation should be mentioned in the bill, against which the material is supplied.
- (e) The M.P. State Agro-Industries Development Corporation Limited shall not be responsible for damages, losses, thefts, pilferage, fire, accidents and demurrages etc. if any, incurred to the consignment during transit and these shall be borne by the supplier.
- (f) The dispatch of consignment shall be immediately communicated to the indenting Regional Manager/Distt. Manager of Corporation and consignee with the relevant details of Challan and Bill Nos.
- (g) **Transit Insurance:** The Supplier will arrange for Transit Insurance and Material supplied should be covered under Transit insurance for Road Risk, Theft, Pilferage, and Non Delivery Risk (R RTPND).

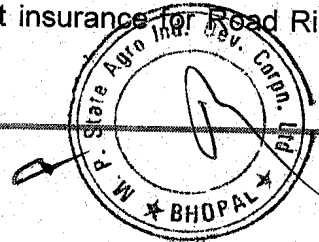

**14. WARRANTEE:**

The Bidder has to declare minimum 1 Years warrantee for the Item supplied by the supplier against any manufacturing defect from the date of Supply and Installation. In case of complaint / defect the supplier shall have to arrange repair /replacement within 10 days from the date of receipt of intimation. The Corporation shall have right to recover the cost or expenditure of loss whatsoever, on this account from the future bills of the supplier or from the security deposit or from any other amount due to the supplier or out of the security or any deposit made by the supplier in other Government Organization. **The Corporation can also Blacklist the Supplier and debarred the supplier from doing the business with the corporation for 1-5 years.**

**Warranty of Tyre Tube will be as per company rules. if any defect occur in the Tyre Tube within the Warrantee Period then it will be replaced by the Vender. Remolded Tyre will not be allowed at any cost .**

**15. TRAINING:**

If required the supplier will impart training to the selected nominated person of purchaser and the concerned person/staff/officers of the Corporation for proper operation and maintenance of Items Supplied.

**16. AFTER SALE SERVICE:**

- a. The company must provide after sales service to the beneficiary for during warranty period.
- b. It shall be the responsibility of the supplier to ensure that necessary spares parts are available to the purchaser/customer of Items during warranty period and after words also. For this purpose Bidder shall keep necessary stock of such fast/slow moving parts on consignment with this corporation {MP Agro} or their stockiest. Quantity and location of stocking points of such items shall be decided by the Bidder.
- c. Supplier shall also ensure that proper after sales services are available to the customers.
- d. The supplier shall also make arrangements for repair and after sale service required on continuous basis after expiry of the warranty period and shall ensure that the repairs/maintenance cost incurred by the purchaser are minimum.

**17. RIGHT TO REFUSE/REJECT THE SUPPLIES:**

- (a) Ordered item shall conform to the quantities specifications (as per **Annexure-IV**) mentioned in supply order. The Corporation reserves the right to refuse to accept the supplied item, if found:-
  - (i) Inferior in quality & not in proper packing or not conforming to the specifications mentioned in **Annexure- III**
  - (ii) Other than specified and ordered by the Corporation,  
OR
  - (iii) For any other sufficient reason at it's discretion.
- (b) In case the supply of supplied item is rejected / the supply not accepted, shall be lifted by supplier at his own cost within the period granted by the M. P. State Agro-Industries Development Corporation Limited and in no case Corporation shall be liable for the supply not accepted.
- (c) If the material fails in the testing.

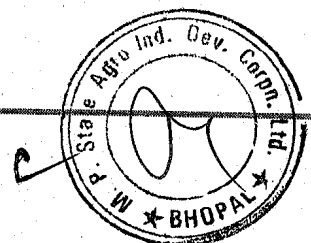

18. **DEFECTIVE SUPPLIES:**

The supplier shall replace the defective material or any other part found defective or prematurely worn out within 7 days within warranty period from the date of sale to the consumer at free of cost. If it is proved that Bidder has intentionally supplied machine/equipments of improper quality or not ready to replace or had not replaced defective machines / equipments during the specified period or in a genuine time period as required minimum, corporation shall be free to black list the Bidder and debar the supplier from doing the business with the corporation for 1-5 years and forfeit the Security Deposits Bidder shall be bound to refund the amount received in lieu of such defective supplies made by the Bidder.

19. **PAYMENT:**

The Corporation will make the payment normally within 15 days on payment after payment condition to the supplier only after receipt of bills along with copy of received challan, GEO TAG photo graph and Third party inspection report, with Receipt duly signed by the consignee / beneficiary and after statutory deduction of taxes and corporation margin.

20. **PRICE ESCALLATION CLAUSE:**

The variation in price is allowed if any variation is occurred in GST slab & any levies/taxes by Regulatory authority. Bidder may revise rates accordingly under intimation to corporation.

21. **RANDOM TESTING OF COMPONENTS:**

Corporation may select sample by random checking of any or all components of System received at the destination / site and send it to any recognized institute for testing. **The cost of such testing including cost of material shall be borne by the supplier.**

22. **BRAND NAME:**

The Bidder is entitled to claim only one brand name for the purpose of this contract. Regarding brand name, certificate of brand name, if any, issued by competent authority for this purpose should be made available, however the Corporation will not be liable for any dispute on account of brand name or of any kind.

23. **SUBMISSION OF REQUIRED DOCUMENT:**

It is obligatory for the Bidder to submit all the necessary documents as mentioned in **Annexure-V** and mentioned elsewhere in RCO document. All formats should be filled in completely. **All the necessary documents should be enclosed duly self-attestation.**

24. **ACCEPTANCE/REJECTION OF RCO:**

The Managing Director of the Corporation reserves the right to accept or reject any or all the RCO without assigning any reason whatsoever at any time prior to the award of the contract, without incurring any liability to the affected Bidder and any obligation to inform the affected Bidder of the grounds.

All the offers shall be examined on the basis of bid and supporting documents submitted online and in case, any of the documents is not in readable/printable form, the offer may be rejected without intimation to the offerer. Please ensure to uploaded clear and proper documents while submitting the bid.

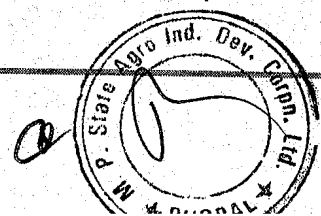

**25. FORCE MAJEURE CLAUSE:**

FMC will applicable in the following circumstances -

- (a) Natural phenomenon including but not limited to weather condition, floods, draught, earthquake and epidemics.
- (b) Acts of government authority domestic or foreign including but not limited to war declared or properties, quarantine restriction.
- (c) Accidents or distraction including but not limited to fire, explosion break downs at essential machinery equipment and power shortage.

**26. PURCHASE PREFERENCE:**

The following rules are applicable only on those items & product which will be approved by committee constituted by M.P. Govt. store purchase rule 2015 (revised 2022) against rule 31 as per store purchase rule.

- (a) In case lowest rate received from the Bidder situated out of Madhya Pradesh. As per the provision made in State Purchase rule 25 to 50 percent (according to the production capacity) will be placed with bidder/bidders whose Production unit situated in Madhya Pradesh (Micro/ Small Industries) and who quoted Rates in bend of L-1+15% (First three bidders of Madhya Pradesh), only if, they are agreeable to supply the material in time and on lowest rate so received. Price preference of any kind will not be allowed (This clause will be applicable to only those Manufacturers of Madhya Pradesh if the place of Manufacturing is situated in Madhya Pradesh)
- (b) As per the policy of the State Government in respect of purchase of items through Micro / Small Industries purchase preference, minimum to the extent of 4% out of 25% of the required quantity shall be given to those manufacturing units of M.P belonging to the SC/ST entrepreneurs. A self-certified copy of certificate issued by the District Trade Industries Center (D.T.I.C) in this regard should be attached at the time of submission of tender. Price preference of any kind will not be allowed.
- (c) As per the policy of the State Government in respect of purchase preference, minimum to the extent of 3% out of 25% of the required quantity shall be given to those manufacturing units of M.P belonging to Female entrepreneurs (Ownership). Preference will be given to Micro / Small Industries run female Self Help Group A self-certified copy of certificate issued by the District Trade Industries Center (D.T.I.C) in this regard should be attached at the time of submission of tender. Price preference of any kind will not be allowed.

**27. TO IMPOSE PENALTIES: In case the supplier does not produce the ordered material within the specified time limit the penalty will be imposed as under**

no	WEEKS	Rate of penalty imposed
1	1 st to 2 nd week	0.25% per week
2	3 rd to 4th week	0.50% per week
3	in Case the supplier refuse to supply the ordered material	Cancelling the supply order and termination of Agreement, Forefeet the Security Deposit and Black listing for 1-5 years.

**28. CORPORATION AS DEALER: Corporation shall become Authorized Dealer of the company after execution of agreement with the company during the currency of Rate Contract.**

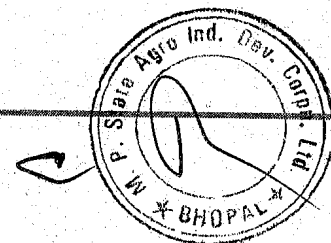

**29. ARBITRATION:**

As far possible, all dispute arising out of this agreement will be settled by the mutual discussion and decision taken by the General Manager marketing of the corporation will be final and binding on both the parties.

In case dispute is not settle as above then the same shall be referred to the arbitration. Arbitration and conciliation Act, 1996 shall apply to the proceedings before the Managing Director of the Corporation who shall be sole arbitrator. The decision of the arbitrator shall be final and binding on the parties. Venue of Arbitration shall be Bhopal and shall be governed by Arbitration and Conciliation act, 1996.

**30. RCO EVALUATION:**

During RCO evaluation, MP AGRO may, at its discretion, ask the Bidder for a clarification of its RCO& documents attached thereto. The request for clarification and response shall be in writing or verbal.

**31. VALIDITY OF RCO RATES:**

The rates finalized against this RCO shall be valid for a period of 3 (three) months from the date of issue of first Rate circular for approved rates. The MP Agro have rights to cancel the approved rates and/or RCO even before completion of its validity period. It will also be at the discretion of MP AGRO to extend validity period upto the new rates are circulated.

**32. MINOR MISTAKES IN RCO:**

M.P. AGRO may waive any minor nonconformity, or irregularity in a RCO document that does not constitute a material deviation, provided such waiver does not prejudice or affect the relative ranking of any bidder. Right to waive mistake shall remain with Managing Director of MPAGRO.

**33. TRANSFERABILITY:**

RCOs are not transferable.

**34. RIGHT TO ACCEPT OR REJECT RATE CONTRACT OFFER:**

MP AGRO reserves the right to reject or accept any rate contract in whole or in part on account of credentials, technical capability, past performance or any other evaluation criteria to ensure uninterrupted supply of material. The decision of MP AGRO in this regard will be final and MP AGRO is not liable to assign any reasons for the decision.

**35. PARALLER RATE CONTRACT:**

MP AGRO reserves the right (a) to enter into parallel rate contract(s) simultaneously or at any time during the period of the rate contract with more Bidders as MP AGRO may think fit, and (b) to place ad-hoc contract or contracts simultaneously at any time during the period of this contract with more supplier(s)/Bidder(s) for such quantity and such item as the competent authority of MP AGRO (whose decision shall be final) may determine.

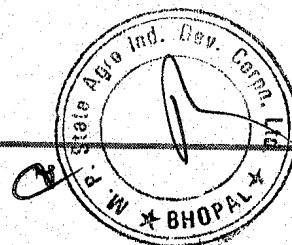

### 36. INSPECTION FOR QUALITY:

Third party inspection of RCO items by Government Department approved by Constitutional Board of **QUALITY COUNCIL OF INDIA** i.e. **NATIONAL ACCREDITATION BOARD FOR CERTIFICATION BODIES** ( N.A.B.C.B) such as **BITES** (Enterprises of Department of Railways Govt of India), **PDIL** (Organization under Department of Chemical and fertilizer Govt of India), **CIPET** (under Department of Chemical and fertilizer Govt of India), **IR-Class** ( Subsidiary firm of Indian Register of Shipping), **National Productivity Council** (Ministry of Commerce and Industries Govt of India), **CIB** Certification and Inspection Body, (Bharat Petroleum Corporation Limited ) or any **Government Engineering College**, any **Government Technical Department** or any **Government institution Govt. Polytechnic Collage, Govt. ITI, MSME Training, ETC.** at Manufacturing Unit and also at the location where the material is supplied. The inspection cost shall be borne by the supplier.

- (i) To certify any materials or part there of submitted for inspection that they are not in accordance with the contract owing to the adoption of any unsatisfactory method of manufacture. MP State Agro may discretionally exercise the power to constitute a committee consisting of external subject matter experts for the purposes of inspection of materials supplied by the manufacturer.
- (ii) To reject any materials submitted as not being in accordance with the particulars.
- (iii) To reject the whole of the installment, if after inspection of such portion thereof as it may in its discretion thinks fit, it is satisfied that the same is unsatisfactory.
- (iv) The Inspecting Officer's decision as regards the rejection shall be final and binding on the Supplier.
- (v) MP AGRO reserves the right to inspect the materials to be dispatched / in Transit / already delivered at any time and at any where. MP AGRO also have rights to inspect the raw materials used for manufacturing, process of manufacturing, quality policy fixed and testing facilities for the product to be supplied by the supplier at the supplier's premises.
- (vi) Cost of Test: The supplier is liable to pay for any Test done on the product
- (vii) supplied for conformity on quality.

### 37. RISK PURCHASE CLAUSE:

MP AGRO reserves the right to make emergent purchase in case of failure of supply/ rejected supply either in part or full as per demand placed by the MP AGRO and amount paid of such purchases should be adjusted from the supplier's Bill and may take following punitive actions.

- a) The occurrence of such events 3 times during the contract period will lead to cancellation of contract by MP AGRO at any time after serving warning on each such event. The cancellation of contract will automatically come into effect from the last working hour of a scheduled delivery date after serving the last warning. On such event of cancellation the supplier will be black listed and will not be allowed to participate in any RCO / supply contract for a period of one year. On event of cancellation of contract the security deposit available with MP AGRO for the contract will be forfeited.

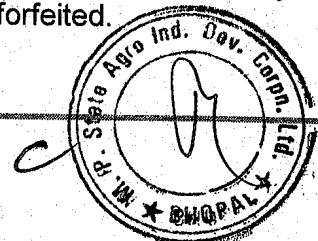

**38. WITHHOLDING AND LIEN IN RESPECT OF SUMS CLAIMED:**

Whenever any claim or claims for payment of a sum of money arises out of or under the contract against the Contractor, MP AGRO shall be entitled to withhold and also have a lien to retain such sum or sums in whole or in part from security, if any, deposited by the Contractor and for the purpose aforesaid, MP AGRO shall be entitled to withhold the said cash security deposit or the security, if any, furnished as the case may be and also have a lien over the same pending finalization or adjudication of any such claims. In the event of the security being insufficient to cover the claimed amount or amounts or if no security has been taken from the Contractor, MP AGRO, shall be entitled to withhold and have lien to retain to the extent of the such claimed amount or amounts, from any sum or sums found payable or which at any time thereafter may become payable to the contractor under the same contract or any other contract with MP AGRO pending finalization or adjudication of any such claim.

**39. CORRUPT PRACTICES:**

Supplier is expected to observe the highest standard of ethics during the execution of this RCO. If the supplier has engaged in corrupt or fraudulent practices, in competing for or in executing the contract, MP AGRO may, after giving 14 days notice to the supplier, terminate the Contract. In pursuit of this policy, MP AGRO:-

- a. Defines, for the purposes of this provision, the terms set forth below as follows:
  - (i) "corrupt practice" means the offering, giving, receiving or soliciting of anything of value to influence the action in the procurement process or in Contract execution; and
  - (ii) "fraudulent practice" means a misrepresentation of facts in order to influence a procurement process or the execution of a contract to the detriment of MP AGRO and includes collusive practices among bidders (prior to or after bid submission) designed to get itself short listed for participating in the bidding process, to establish bid prices at artificial, non-competitive levels and to deprive MP AGRO of the benefits of free and open competition;
- b. Will reject a proposal for award if it determines that the Bidder being considered for award has engaged in corrupt or fraudulent practices in competing for the Contract.
- c. In the same manner as above, if bidder observes any corrupt practices or "fraudulent practice" in MP AGRO, he should report to Managing Director only.

**40. BREACH OF CONTRACT:**

Any breach of the terms & conditions mentioned in this RCO document by the Supplier, or any one employed by him or acting on his behalf (whether with or without the knowledge of the Supplier) or the committing of any offence by the Supplier or by any one employed by him or acting on his behalf under Chapter IX of the Indian Penal Code, 1860 or the Prevention of Corruption Act, 1988 or any other act enacted for the prevention of corruption by public servants shall entitle MP AGRO to cancel the contract and all or any other contracts with the Supplier and to recover from the Supplier the amount of any loss arising from such cancellation.

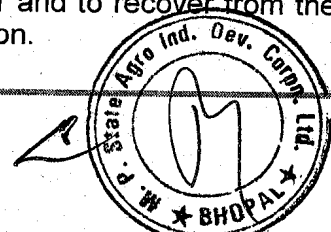

**41. TERMINATION OF CONTRACT AND BLACK LIST OF SUPPLIER :**

MP AGRO may terminate of Contract or Black list of supplier in the following event of default:

- (i) Breach of any of the terms or conditions or obligation of Contract on part of Supplier / his employees /agents.
- (ii) **Any major material alteration in the agreed upon specification (if any) of the product to be supplied without the authorization of MP AGRO and / or competent authority or non supply or delay in supply in the reference of point no 27.**
- (iii) MP AGRO at their discretion may call for any record to satisfy themselves regarding supply of material to catering units. The supplier shall provide every help/ document related to MP AGRO, failing which it may amount to breach of condition of the contract.
- (iv) The Supplier being adjudged bankrupt/ insolvent or a trustee/ receiver being appointed on the Supplier.
- (v) Repudiation of agreement by Supplier or otherwise evidence of intention not to be bound by the agreement.
- (vi) MP AGRO at their discretion may call for any record to satisfy them regarding the supply and Supplier will provide every help failing which it may amount to breach of condition of the Contract.

**42. AMENDMENTS TO BID INVITATION:**

The MP AGRO reserves the right, to make revisions or amendments to the bid documents, when deemed necessary, prior to the closing date of the bid, through proper notification or web-site. The bidders must watch MP AGRO web site for any such amendments. The MP AGRO shall be at liberty to consider extending the date set for the bid opening by such a number of days as in the opinion of the MP AGRO will seem necessary.

**43. NEGOTIATIONS:**

- (i) It is clarified that normally the Corporation will make no negotiation on the RCO and therefore the Bidders should quote their lowest Basic prices only. However the Managing Director of the Corporation may decide to give counter RCO of the lowest rate as decided by him.
- (ii) On the basis of lowest rate received in the financial bid corporation will ask other bidders to execute agreement provided other bidders are agreed to it.

**44. AUTHORITY TO SIGN BID DOCUMENTS:**

A person signing the RCO or any other document in respect of the Contract on behalf of the supplier without disclosing his authority to do so shall be deemed to warrant that he has authority to bind the Supplier. If it is discovered at any time that the person so signing has no authority to do so, MP AGRO may, without prejudice to any other right or remedy of MP AGRO, cancel the contract and make or authorize making of a purchase of the materials at the risk and cost of such person, and hold such person liable to MP AGRO for all costs and damages arising from the cancellation of the contract including any loss which MP AGRO may sustain on account of such purchase.

**45.** Only Bhopal Court shall have jurisdiction.

**MANAGER (MARKETING)**

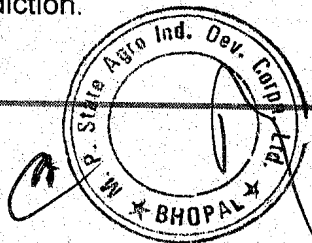

**ANNEXURE - VIII**

**THE MADHYA PRADESH STATE AGRO INDUSTRIES DEVELOPMENT  
CORPORATION LIMITED**

**LETTER OF UNDERTAKING AND DECLARATION**

We ..... hereby submit RCO for the supply of  
..... conforming to the Specifications as mentioned in RCO.

We undertake to supply such quantities of material as per Specification as mentioned in RCO, as we may be called upon to supply and install under the conditions here-to enclosed during the allotted period from the date of execution of the agreement on the rates agreed upon, at the places to be specified by the M.P. State Agro Industries Development Corporation Limited within the specified delivery period.

We undertake that presently our firm is not Blacklisted/Debarred by any Government / Government Undertaking /Bank nor penalized on the same ground. We also undertake that no legal proceeding is pending in any Courts on the same grounds.

We hereby agree to abide by and fulfill all the terms and conditions of contract annexed hereto and in default thereof to forfeit and pay to the M.P. State Agro Industries Development Corporation Limited, the penalties or sum of money mentioned in the said conditions.

The sum of Rs. 1,00,000.00 (One Lakh only) in the form of Demand draft or any of the form specified in the Rate Contract RCO Documents is herewith forwarded as Earnest Money which shall be retained by The MP State Agro Industries Development Corporation Limited, on account of Security Deposit as specified in the clause 9 of the said conditions of contract, should this RCO be accepted.

"I have read and fully understood the terms and conditions of supplies etc. mentioned in the documents.

Name :.....

Designation:.....

(Signature with Office Seal..)

Witness:

1.

2.

THE RATE CONTRACT RCO IS HEREBY ACCEPTED BY ME ON BE HALF OF

M/s.....

SIGNATURE OF THE ACCEPTING AUTHORITY

**Note: Letter of acceptance of RCO is to be submitted on Noterised non judicial stamp of Rs 500.00**

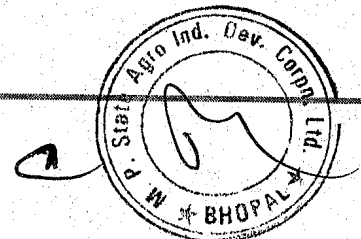



**THE MADHYA PRADESH STATE AGRO INDUSTRIES DEVELOPMENT CORPORATION LIMITED**

"PANCHANAN" 3rd FLOOR, MALAVIYA NAGAR, BHOPAL  
Phone (0755)- 2551652, 2551756, 2761392, Fax: 0755-2557305

**ANNEXURE - IX**

**FINANCIAL BID FORMAT**

S. N.	ITEM DESCRIPTION	UNIT	HSN CODE	BASIC AGRO PURCHASE RATE
<b><u>M.S. WATER TANKER</u></b>				
1.	M.S. WATER TANKER MOUNTED ON TWO WHEEL TRACTOR TRAILER CAPACITY 5000 LITER WITH 900x16 NEW TYRES. <b>MODEL - 1</b>	1	HSN CODE 871631	
2.	M.S. WATER TANKER MOUNTED ON TWO WHEEL TRACTOR TRAILER CAPACITY 5000 LITER WITH NEW 900x20 TYRES. <b>MODEL - 2</b>	1	HSN CODE 871631	
3.	M.S. WATER TANKER MOUNTED ON TWO WHEEL TRACTOR TRAILER CAPACITY 5500 LITER WITH 900x16 NEW TYRES. <b>MODEL - 3</b>	1	HSN CODE 871631	
4.	M.S. WATER TANKER MOUNTED ON TWO WHEEL TRACTOR TRAILER CAPACITY 5500 LITER WITH 900x20 NEW TYRES. <b>MODEL - 4</b>	1	HSN CODE 871631	
5.	M.S. WATER TANKER MOUNTED ON TWO WHEEL TRACTOR TRAILER CAPACITY 5000 LITER WITH FIRE FIGHTING PUMP AND 900x16 NEW TYRES. <b>MODEL - 5</b>	1	HSN CODE 871631	
6.	M.S. WATER TANKER MOUNTED ON TWO WHEEL TRACTOR TRAILER CAPACITY 5000 LITER WITH FIRE FIGHTING PUMP AND 900x20 NEW TYRES. <b>MODEL - 6</b>	1	HSN CODE 871631	
<b><u>G.I. WATER TANKER</u></b>				
7.	G.I. WATER TANKER MOUNTED ON TWO WHEEL TRACTOR TRAILER CAPACITY 5000 LITER WITH 900x16 NEW TYRES. <b>MODEL - 7</b>	Each	HSN CODE 871631	
8.	G.I. WATER TANKER MOUNTED ON TWO WHEEL TRACTOR TRAILER CAPACITY 5000 LITER WITH NEW 900x20 TYRES. <b>MODEL - 8</b>	Each	HSN CODE 871631	
9.	G.I. WATER TANKER MOUNTED ON TWO WHEEL TRACTOR TRAILER CAPACITY 5500 LITER WITH 900x16 NEW TYRES. <b>MODEL - 9</b>	Each	HSN CODE 871631	
10.	G.I. WATER TANKER MOUNTED ON TWO WHEEL TRACTOR TRAILER CAPACITY 5500 LITER WITH 900x20 NEW TYRES. <b>MODEL - 10</b>	Each	HSN CODE 871631	
11.	G.I. WATER TANKER MOUNTED ON TWO WHEEL TRACTOR TRAILER CAPACITY 5000 LITER WITH FIRE FIGHTING PUMP AND 900x16 NEW TYRES. <b>MODEL - 11</b>	Each	HSN CODE 871631	
12.	G.I. WATER TANKER MOUNTED ON TWO WHEEL TRACTOR TRAILER CAPACITY 5000 LITER WITH FIRE FIGHTING PUMP AND 900x20 NEW TYRES. <b>MODEL - 12</b>	Each	HSN CODE 871631	

Seal & signature  
of the Bidder

**DECLARATION OF BLACKLISTING**

I/We M/S.....hereby declare that neither I/We nor our Start-up or a parent, subsidiary or associate Company under direct or indirect common parent is/are presently not Black list / Debar/Penalized by any Public Sector Company in India or by any Department of State or Central Government and that there is no pending inquiry by any Public Sector Company in India or by any Department of State or Central Government, against us or a parent, subsidiary or associate Company as aforesaid in India, in respect of criminal, corrupt or fraudulent practice(s), is NIL.

It is understood that if this Declaration is found to be false, MP AGRO shall have the right to reject my/our proposal, and if the proposal has resulted in an investment, the investment agreement is liable to be terminated without prejudice to any other right or remedy (including Black list / Debar/Penalized) available to MP AGRO.

Place:

Date:

**Seal & Signature of the Bidder  
or their authorized Representative**

**NOTE:** This declaration should be furnished on company's "Letter Head"

**DRAFT AGREEMENT**

*(THIS AGREEMENT TO BE FURNISHED AFTER THE BID IS  
ACCEPTED ON NON JUDICIAL STAMP RS. 1000/-)*

This agreement made at Bhopal this day of....., between The Madhya Pradesh State Agro-Industries Development Corporation, having registered office at 'Panchanan, 3rd Floor, Malviya Nagar, Bhopal, M.P. hereinafter referred to as 'Corporation' which expression shall unless repugnant to the context or meaning there of include its successors and assigns on the one part.

AND

M/s. .... having its office at .....  
----- acting through its ..... (hereinafter referred to as the Supplier  
which expression unless repugnant to the context and meaning there of includes its assigns,  
successors and administrations on the other part.

WHEREAS the Corporation invited Rate Contract RCO for supply of .....  
..... on the terms and conditions envisaged in the terms  
schedule issued with the Rate Contract RCO Document and purchased by the supplier.

AND WHEREAS the supplier has accepted each and every term and condition contained in  
the Rate Contract RCO Document, while submitting his RCO. The supplier has agreed to  
supply of quality materials and equipments on consignment basis on the terms and  
conditions of this agreement to the Corporation.

AND WHEREAS the Corporation accepted the RCO submitted by the supplier vide its letter  
of acceptance no. .... dated -----in consideration of the mutual premises  
and undertakings hereinafter specified and for other good and valuable consideration this  
agreement witness and is hereby agreed on the conditions of the RCO and the following  
documents shall form and be constructed a part of the Agreement Deed: -

-----2

:: 02 ::

- a) The terms & conditions of the Rate Contract Document
- b) Specifications of material
- c) The letter of acceptance dated -----
- d) The RCO submitted by the supplier.
- e] The rates mentioned in annexure to agreement.

The aforesaid documents shall be taken as complementary and mutually explanatory of one another but in case of discrepancies and ambiguities shall take precedence in the order set out above. In this regard the decision of Managing Director, M.P. State Agro-Industries Development Corporation Limited shall be final.

For Supplier

.....  
.....  
.....

For

M.P. STATE AGRO INDUSTRIES  
DEVELOPMENT CORPORATION LTD

Signature with Office Seal

  
MANAGER, MARKETING

Witnesses

1.

2.

**ANNEXURE - XII**

**FORMAT FOR C.A. CERTIFICATE FOR TURN OVER**

We have verified the books of accounts and other relevant records of M/s -----  
----- Based on my verification and as per the information and  
explanation given to us, we certify financial turnover for Fabrication Items of M/s -----  
----- as under :-

Year	Turnover Rs In Lakhs
Financial Year 2022-23	
Financial Year 2023-24	
Financial Year 2024-25	
Total	

For  
Chartered Accountant  
Seal and Signature  
UDIN No. -----

Place : .....

Date : .....

(to be submitted on CA's letter head)

**FORMAT FOR SIGNING AUTHORITY ON THE FIRMS LETTER HEAD**

To,  
The Manager,  
M.P.S.A.I.D.C, 111rd Floor,  
Panchanan Bhavan, Malviya Nagar,  
Bhopal.

**Sub : Regarding signing authority.**

I/We ..... undersigned in the capacity of Proprietor/  
Partner/ Board of Director of the firm M/s .....  
having office at ..... hereby authorise our employee named Shri  
..... holding the position of ..... to sign in the RCO and  
related document on behalf of the firm.

Signing person on the document  
Name:  
Designation and Seal.

Attested and authorised by :-

Proprietor/ Partner/ Board of Director.  
Name :-  
Designation and Seal

Seal of the Firm

## **TECHNICAL SPECIFICATIONS**

### **M.S. WATER TANKER MOUNTED ON TWO WHEEL AGRICULTURE TRACTOR TRAILER CAPACITY 5000 Lit. & 5500 Lit. WITH 9.00X16 NEW TYRE AND TUBE**

#### **1. Chassis:**

The chassis shall be fabricated as per standard practice to mount the M.S. Tank. All the joint shall be welded properly as per standard practice. The chassis frame have two longitudinal members having ISMC 150 x 75 mm channel section or Auto channel of size 150 x 75 mm having same specification and both having 5 cross member of the ISMC channel 150 x 75 mm.

The overall approximate dimensions of various tanker trolley chassis shall be as under :--

<b>S. No.</b>	<b>Approximate Capacity</b>	<b>Length</b>	<b>Width</b>
1.	5000 Liter.	3450 mm.	1000 mm.
2.	5500 Liter.	3450 mm.	1000 mm.

#### **2. Draw Bar ( Chassis ) :**

Draw Bar shall be Triangular v shape welded together at v joint and other side both member at main chassis channel section overlapped at least 300 mm. Draw Bar shall be made out of ISMC 150 x75 mm channel section or Auto channel of size 150 x 75 mm having same specification with eye hook made out of 40 mm. diameter MS round bar.

#### **3. Axle Assembly :**

Axle shall be made from solid square bar of 75 mm or 85 mm hollow square tube section with both the end machined and threaded and provided with iron hubs with 8 holes and minimum 20 mm. thick with hexagonal lock nut, fitted with twin taper roller bearing no. 32213 & 32216 provided with grease nipples for greasing the moving parts.

#### **4. Leaf Spring :**

Two set of leaf spring consisting of 19 leaves of size 70 x 10 mm. minimum 900 mm. long ( distance between two pin ) of alloy steel shall be provided. These leaf spring shall be fixed with frame by means of complete cast iron/Steel bracket assembly.

#### **5. Tyre Tubes & Wheel Assembly :**

Two number of New tyres 9.00 x 16 with tube & flap assembly of slandered make ( MRF, Ceat, Hercules, JK, Apollo, Birla, Modi, Michigan, Goodyear, Bridgestone, Yokohama etc) shall be provided with double plated rim 5 mm. thick with 8 No. of holes. **Remoulded Tyres will not be allowed at any cost.**

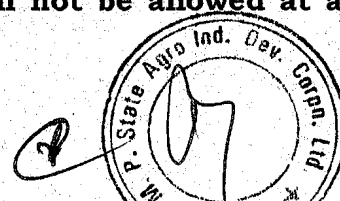

### **Shell of the Water Tanker :-**

The water tanker should have capacity of approximate 5000 lit. and 5500 liters, manufactured in semi elliptical shape. The tank shall be made out of 3.0 mm. thick MS sheet , and maximum number of plates are not more than 4 No., End plates of the tank shall be made of 3.00 mm thick M.S. sheet with maximum in joint of two No. plate.

<b>. No.</b>	<b>Approximate Capacity</b>	<b>Major Axis</b>	<b>Minor Axis</b>	<b>Length</b>
1.	5000 Liter.	1675 mm.	1275 mm.	3000 mm.
2.	5500 Liter.	1710 mm.	1310 mm.	3100 mm.

### **7. Baffle Plate :-**

One baffle plate made of 3.00 mm. shall be provided inside the tank over center reinforcement ( plus shape) shall be properly welded with the two angle in plus position touching major & minor axis peak points. The height of the baffle plate shall be just 20 c.m. above over half of the minor axis of the tank.

### **8. Reinforcement or Grooving :-**

The tank shall be reinforcement from inside by welding three number of elliptica rings made of 40 x 40 x 6 mm. M.S. angle on both ends and one in between at suitable distance or making minimum three grooves or grooved strips on the entire circumference of the shell by press machine.

### **9. Manhole:-**

One manhole with hinged cover shall be provided at the top of the tank. The cover of the tank shall be fabricated by 3.00 mm thick M.S. sheet. The collar of the cover and manhole shall be made out of 4.00 mm. MS strip. Locking arrangement for cover shall also be provided. The man hole cover shall be such fabricated so that no foreign material may not enter in the tank.

The shell of the tank shall be rested on the chassis by means of six number of suitable fabricated shoes ( box type bracket) of 4 mm. thick plate or molded having 2.5 mm. plates. sheet brackets guide made out One ladder shall be made of 25 x 25 x 3mm I.S.A. or fabricated foot rest on the front end plates with handle.

### **10. Pump set stand :-**

Pump Set Stand shall be made of ISMC 150 x 75 mm. channel or Auto channel of size 150 x 75 mm having same specification.

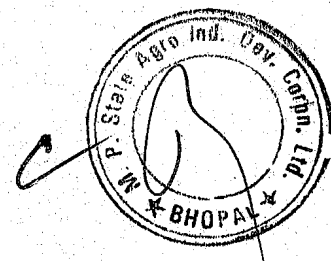

**11. General requirements of all types of Tanker:--**

**1. Outlet:--**

63 mm. NB class "A" GI nipple of 10 cm length (minimum) be provided at the rear of the tank along with required 75 mm steel ball valve .

**2. Painting & Finishing**

The tanker should be spray painted, with priming coat of red oxide and two coat of synthetic enamel paint and colour as desired by consignee. Interior of the tank should be painted with suitable primer followed by Non-poisonous rubber paint.

**3. Guarantee**

The manufacturer shall furnish guarantee for two year against manufacturing defects, leakage etc., along with tender incorporating that in case of complaint they shall undertake satisfactory repair within 10 days free of coat.

**4. Inspection**

The quality inspection of water tanker shall be carried out by the Third Party inspection agency nominated by M.P. Agro.

**5. Tolerance :--**

± 2.5% Tolerance shall be allowed.

**6. Radium Triangular Reflection Board :--**

A Triangular Plastic Radium Reflection Board should be fitted on the rear side of the tanker shell. Each side of the triangular board are 300 x 300 x 300 mm in length and 5 mm thickness.

**Note : If required minor deviation / amendment in specification may be done, after taking approval from M.P. Agro.**

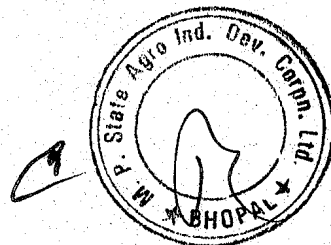

**M.S. WATER TANKER MOUNTED ON TWO WHEEL AGRICULTURE  
TRACTOR TRAILER CAPACITY 5000 Lit. & 5500 Lit. WITH 9.00X20  
NEW TYRE AND TUBE**

**1. Chassis:**

The chassis shall be fabricated as per standard practice to mount the M.S. Tank. All the joint shall be welded properly as per standard practice. The chassis frame have two longitudinal members having ISMC 150 x 75 mm channel section or Auto channel of size 150 x 75 mm having same specification and both having 5 cross member of the ISMC channel 150 x 75 mm.

The overall approximate dimensions of various tanker trolley chassis shall be as under :--

S. No.	Approximate Capacity	Length	Width
1.	5000 Liter.	3450 mm.	1000 mm.
2.	5500 Liter.	3450 mm.	1000 mm.

**2. Draw Bar ( Chassis) :**

Draw Bar shall be Triangular v shape welded together at v joint and other side both member at main chassis channel section overlapped at least 300 mm. Draw Bar shall be made out of ISMC 150 x75 mm channel section or Auto channel of size 150 x 75 mm having same specification with eye hook made out of 40 mm. diameter MS round bar.

**3. Axle Assembly :**

Axle shall be made from solid square bar of 75 mm or 85 mm hollow square tube section with both the end machined and threaded and provided with iron hubs with 8 holes and minimum 20 mm. thick with hexagonal lock nut, fitted with twin taper roller bearing no. 32213 & 32216 provided with grease nipples for greasing the moving parts.

**4. Leaf Spring :**

Two set of leaf spring consisting of 19 leaves of size 70 x 10 mm. minimum 900 mm. long ( distance between two pin ) of alloy steel shall be provided. These leaf spring shall be fixed with frame by means of complete cast iron/Steel bracket assembly.

**5. Tyre Tubes & Wheel Assembly :**

Two number of New tyres 9.00 x 16 with tube & flap assembly of slandered make ( MRF, Ceat, Hercules, JK, Apolo, Birla, Modi, Michigan, Goodyear, Bridgestone, Yokohama etc) shall be provided with double plated rim 5 mm. thick with 8 New Holes. **Remoulded Tyres will not be allowed at any cost**

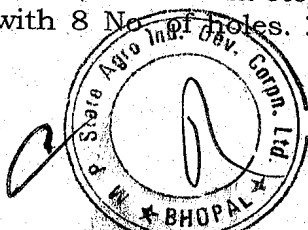

**6. Shell of the Water Tank :-**

The water tanker should have capacity of approximate 5000 lit. and 5500 liters, manufactured in semi elliptical shape. The tank shall be made out of 3.0 mm. thick MS sheet , and maximum number of plates are not more than 4 No., End plates of the tank shall be made of 3.00 mm thick M.S. sheet with maximum in joint of two No. plate.

S. No.	Approximate Capacity	Major Axis	Minor Axis	Length
1.	5000 Liter.	1675 mm.	1275 mm.	3000 mm.
2.	5500 Liter.	1710 mm.	1310 mm.	3010 mm.

**7. Baffle Plate :-**

One baffle plate made of 3.00 mm. shall be provided inside the tank over center reinforcement ( plus shape) shall be properly welded with the two angle in plus position touching major & minor axis peak points. The height of the baffle plate shall be just 20 c.m. above over half of the minor axis of the tank.

**8. Reinforcement or Grooving :-**

The tank shall be reinforcement from inside by welding three number of elliptica rings made of 40 x 40 x 6 mm. M.S. angle on both ends and one in between at suitable distance or making minimum three grooves or grooved strips on the entire circumference of the shell by press machine.

**9. Manhole:-**

One manhole with hinged cover shall be provided at the top of the tank . The cover of the tank shall be fabricated by 3.00 mm thick M.S. sheet. The collar of the cover and manhole shall be made out of 4.00 mm. MS strip. Locking arrangement for cover shall also be provided. The man hole cover shall be such fabricated so that no foreign material may not enter in the tank.

The shell of the tank shall be rested on the chassis by means of six number of suitable fabricated shoes ( box type bracket) of 4 mm. thick plate or molded having 2.5 mm. plates. sheet brackets guide made out

One ladder shall be made of 25 x 25 x 3mm I.S.A. or fabricated foot rest on the front end plates with handle.

**10. Pump set stand :-**

Pump Set Stand shall be made of ISMC 150 x 75 mm. channel or Auto channel of size 150 x 75 mm having same specification.

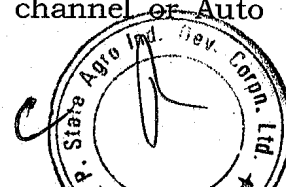

**11. General requirements of all types of Tanker:--**

**1. Outlet:--**

63 mm. NB class "A" GI nipple of 10 cm length (minimum) be provided at the rear of the tank along with required 75 mm cast Iron/steel ball valve/PVC Ball valve.

**2. Painting & Finishing**

The tanker should be spray painted, with priming coat of red oxide and two coat of synthetic enamel paint and colour as desired by consignee. Interior of the tank should be painted with suitable primer followed by Non-poisonous rubber paint.

**3. Guarantee**

The manufacturer shall furnish guarantee for two year against manufacturing defects, leakage etc., along with tender incorporating that in case of complaint they shall undertake satisfactory repair within 10 days free of coat.

**4. Inspection**

The quality inspection of water tanker shall be carried out by the Third Party inspection agency nominated by M.P. Agro.

**5. Tolerance**

± 2.5% Tolerance shall be allowed.

**6. Radium Triangular Reflection Board :--**

A triangular Plastic Radium Reflection Board should be fitted on the rear side of the tanker shell. Each side of the triangular board are 300 x 300 x 300 mm in length and 5 mm thickness.

**Note :--If required minor deviation / amendment in specification may be done, after taking approval from M.P. Agro.**

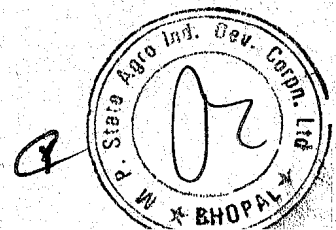

# Schematic Drawing of M.S. Water Tanker capacity 5000 lit. & 5500 Lit. with 900 x 16 & 900x 20 Tyre

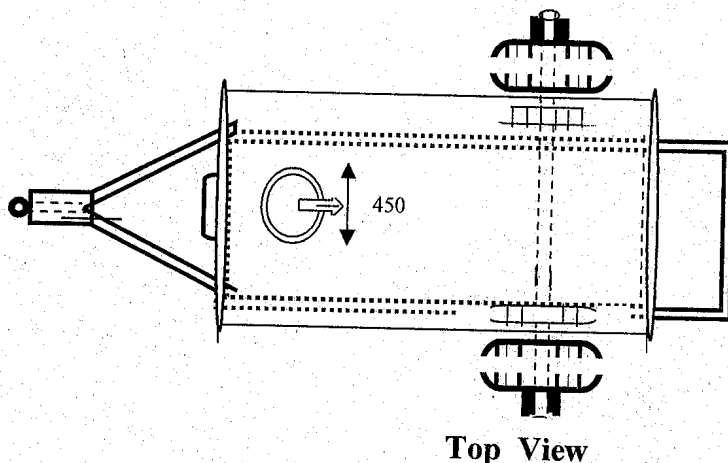
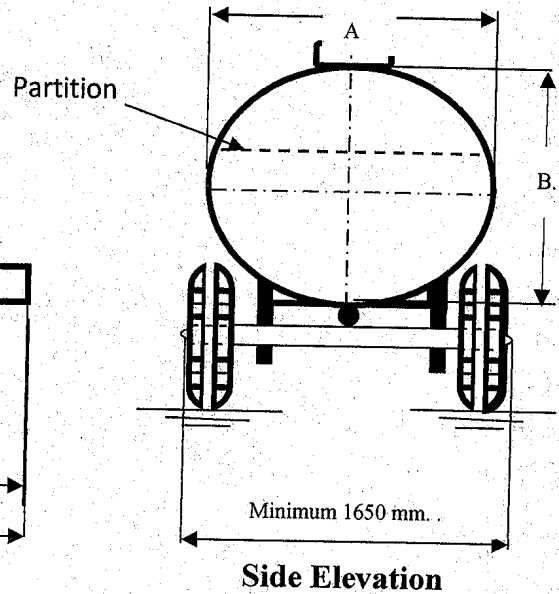
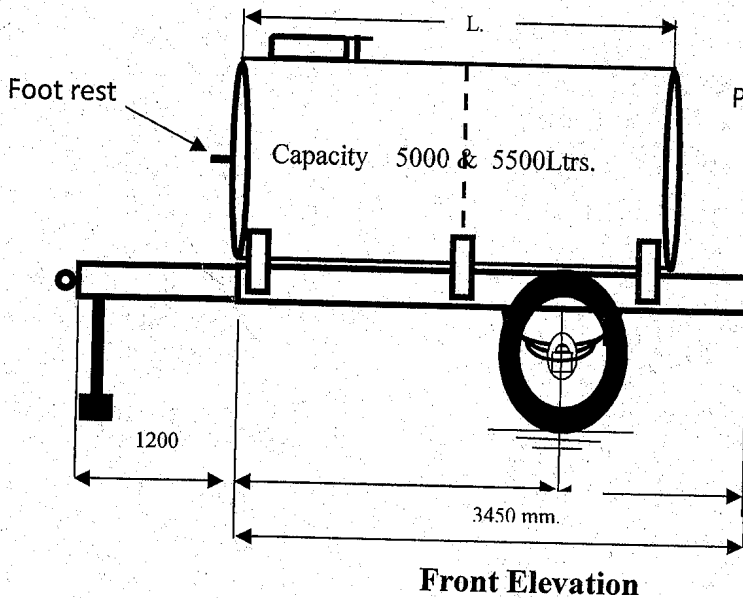

**U BOLT 20 mm. DIA  
SIZE 583 mm x 75  
mm x 583 mm.**

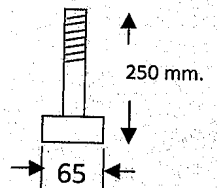

**HEXAGONAL NUT &  
BOLT 250 x 65 mm.**

1. TYRES TUBE & FLAP	:-	2 Nos.	900 x 16 or 900 x 20
2. WATER TANKER SHELL FOR 5000 Lit.	:-		1675 mm. x 1275 mm x 3000 mm.
3. WATER TANKER SHELL FOR 5500 Lit.	:-		1710 mm. x 1310 mm. x 3100 mm.
4. WATER TANKER SHEET THICKNESS	:-		3.0 mm. M.S. Sheet.
5. LAMINATED SPRING 19 LEAVES	:-	2 Set.	70 x 10 mm., Eye to Eye --- 900 mm.
6. CHASSIS FRAME	:-		150 x 75 ISMC, L= 3400mm, W= 1000mm
7. AXLE	:-	1 No.	75mm (Solid bar)/85mm (hollow) x ≥1650mm
8. DRAW BAR	:-		150 x 75 ISMC, L= 1200 mm, W= 1000mm
9. U BOLT	:-	8 Nos.	18 mm., 7x3x7 Inch.
10. DRAW BAR HOOK	:-	1 No	Diameter 40 mm., Length 250 mm.
11. STEEL HUB	:-		2 Nos 20 mm. thick, 8 hole
12. DOUBLE PLATED RIM	:-	2 Nos	5 mm. thick.
13. BEARING	:-	2 Set.	32213 & 32216 NO.
14. STEEL HANGER & SHACKLE	:-	4 Set	As per ISMC 150 x 75 mm.
15. NET WEIGHT 5000 & 5500 Lit	:-		Up to 850 Kg. Approx
16. GROSS WEIGHT 5000 & 5500 Lit.	:-		5850 Kg. & 6350 Kg. Approx
17. MAN HOLE	:-		Collar W=450 mm, T= 4mm, Cover= 3mm

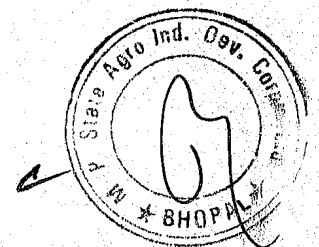

# Design of End Plate of Tanker

End plates of tanker shall be made of 3.0 mm. M.S. sheet in a dish end shape. Sheet should be in a single piece and bend on the periphery to give strength or flat end with inside stiffener angle of 3.0 mm all around on both end.

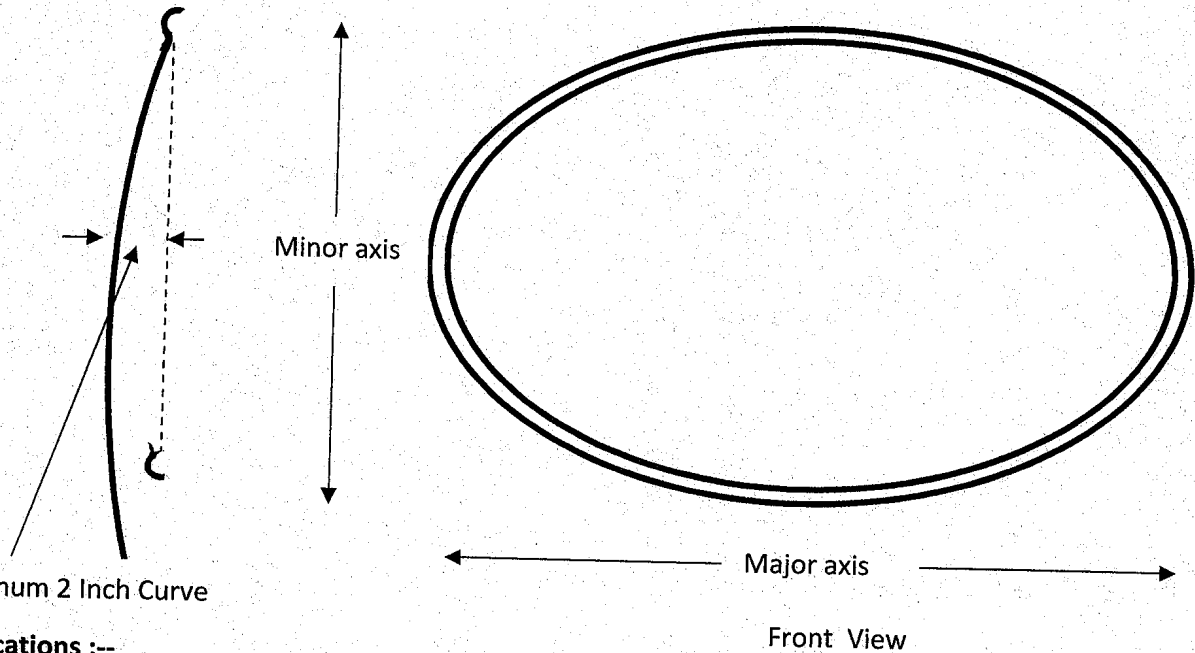

## Specifications :--

### For 5000 liter.

- Major axis ---- 1675 mm
- Minor axis ---- 1275 mm.
- Dish end curve ---- Min. 2 Inch.
- Welding with shell ---- Lap joint.

### For 5500 liter.

- Major axis ---- 1710 mm.
- Minor axis ---- 1310 mm.
- Dish end curve ---- Min. 2 Inches.
- Welding with shell ---- Lap joint.

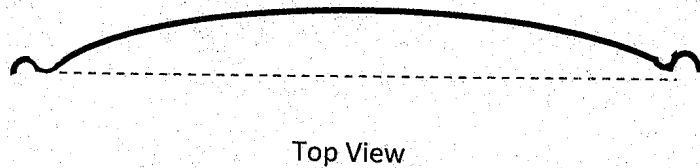

## Water distribution of Tanker :--

### Capacity Calculation

Capacity of the Tanker in Liters

$$\pi \times \text{Major Axis} \times \text{Minor Axis} \times \text{Length}$$

$$4 \times 1000$$

Major Minor Axis & Length in Centimetres

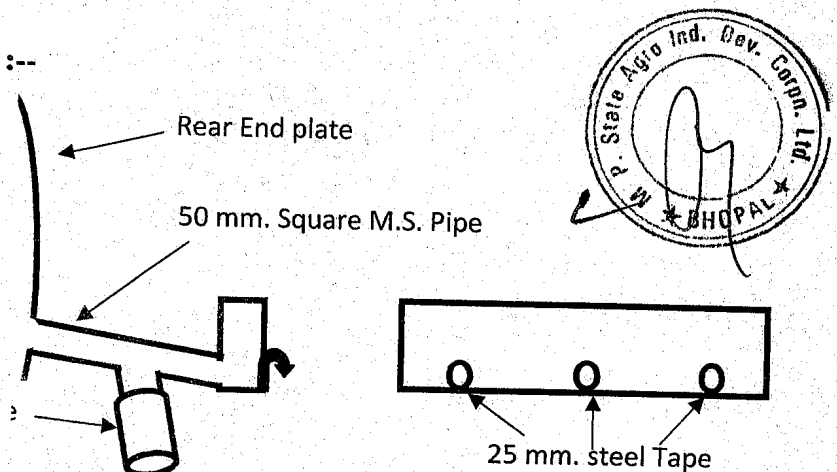

**M.S. WATER TANKER MOUNTED ON TWO WHEEL AGRICULTURE  
TRACTOR TRAILER CAPACITY 5000 Lit. WITH 900 x 16 & 9.00X20  
NEW TYRE AND TUBE WITH FIRE FIGHTING PUMP & ACCESSORIES**

**1. Chassis:**

The chassis shall be fabricated as per standard practice to mount the M.S. Tank. All the joint shall be welded properly as per standard practice.

The chassis frame have two longitudinal members having ISMC 150 x 75 mm channel section or Auto channel of size 150 x 75 mm having same specification and both having 5 cross member of the ISMC channel 150 x 75 mm.

The overall approximate dimensions of various tanker trolley chassis shall be as under :--

S. No.	Approximate Capacity	Length	Width
1.	5000 Liter.	3450 mm.	1000 mm.
2.	5500 Liter.	3450 mm.	1000 mm.

**2. Draw Bar ( Chassis) :**

Draw Bar shall be Triangular v shape welded together at v joint and other side both member at main chassis channel section overlapped at least 300 mm. Draw Bar shall be made out of ISMC 150 x75 mm channel section or Auto channel of size 150 x 75 mm having same specification with eye hook made out of 40 mm. diameter MS round bar.

**3. Axle Assembly :**

Axle shall be made from solid square bar of 75 mm or 85 mm hollow square tube section with both the end machined and threaded and provided with iron hubs with 8 holes and minimum 20 mm. thick with hexagonal lock nut, fitted with twin taper roller bearing no. 32213 & 32216 provided with grease nipples for greasing the moving parts.

**4. Leaf Spring :**

Two set of leaf spring consisting of 19 leaves of size 70 x 10 mm. minimum 900 mm. long ( distance between two pin ) of alloy steel shall be provided. These leaf spring shall be fixed with frame by means of complete cast iron/Steel bracket assembly.

**5. Tyre Tubes & Wheel Assembly :**

Two number of New tyres 900 x 16 or 9.00 x 20 with tube & flap assembly of slandered make ( MRF, Ceat, Harculus, JK, Apolo, Birla, Modi, Michigan, Goodyear, Bridgestone Yokohama etc. ) shall be provided with double plated rim 5 mm. thick with 8 No. of holes. **Remouled Tyres will not be allowed at any cost.**

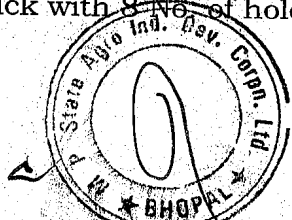

**6. Shell of the Water Tank :-**

The water tanker should have capacity of approximate 5000 lit. and 5500 liters, manufactured in semi elliptical shape. The tank shall be made out of 3.0 mm. thick MS sheet , and maximum number of plates are not more than 4 No., End plates of the tank shall be made of 3.00 mm thick M.S. sheet with maximum in joint of two No. plate.

S. No.	Approximate Capacity	Major Axis	Minor Axis	Length
1.	5000 Liter.	1675 mm.	1275 mm.	3000 mm.

**7. Baffle Plate :-**

One baffle plate made of 3.00 mm. shall be provided inside the tank over center reinforcement ( plus shape) shall be properly welded with the two angle in plus position touching major & minor axis peak points. The height of the baffle plate shall be just 20 c.m. above over half of the minor axis of the tank.

**8. Reinforcement or Grooving :-**

The tank shall be reinforcement from inside by welding three number of elliptica rings made of 40 x 40 x 6 mm. M.S. angle on both ends and one in between at suitable distance or making minimum three grooves or grooved strips on the entire circumference of the shell by press machine.

**9. Manhole:-**

One manhole with hinged cover shall be provided at the top of the tank . The cover of the tank shall be fabricated by 3.00 mm thick M.S. sheet. The collar of the cover and manhole shall be made out of 4.00 mm. MS strip. Locking arrangement for cover shall also be provided. The man hole cover shall be such fabricated so that no foreign material may not enter in the tank.

The shell of the tank shall be rested on the chassis by means of six number of suitable fabricated shoes ( box type bracket) of 4 mm. thick plate or molded having 2.5 mm. plates. sheet brackets guide made out One ladder shall be made of 25 x 25 x 3mm I.S.A. or fabricated foot rest on the front end plates with handle.

**10. Pump set stand :-**

Pump Set Stand shall be made of ISMC 150 x 75 mm. channel or Auto channel of size 150 x 75 mm having same specification.

**11 Fire Fighter :-**

Medium duty centrifugal pump assembly is driven by pulley ( Increased velocity ratio from 1 to 3 ) drive & connected with P.T.O. shaft of the tractor by means of propeller shaft & universal joint assembly.

Size range :- 65 mm x 50 mm.

R.P.M. :- 1400 to 1500

Req. H.P. :- 12.5 H.P.

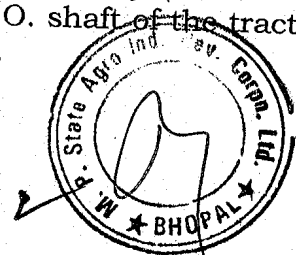

Out let of the pump is attached with 50 mm. cotton flexible fabric delivery pipe of 15 mtr. Length followed with Aluminum Nozzle assembly along with GI Box (with reel system) in which the delivery pipe stored properly. Inlet or suction pipe having 50/63 mm. diameter flexible green hose pipe of 6 mtr. Length followed 50/63 mm. PVC foot valve.

OR

6.5 H.P. engine is fitted on the rear side of chassis with Centrifugal pump with Out let of the pump is attached with 50 mm. cotton flexible fabric delivery pipe of 15 mtr. Length followed with Aluminum Nozzle assembly along with GI Box (with reel system) in which the delivery pipe stored properly. Inlet or suction pipe having 50/63 mm. diameter flexible green hose pipe of 6 mtr. Length followed 50/63 mm. PVC foot valve.

**4. General requirements of all types of Tanker:--**

**1. Outlet:--**

63 mm. NB class "A" GI nipple of 1 cm length (minimum) be provided at the rear of the tank along with required 75 mm cast Iron/steel ball valve/PVC Ball valve.

**2. Painting & Finishing**

The tanker should be spray painted, with priming coat of red oxide and two coat of synthetic enamel paint and colour as desired by consignee. Interior of the tank should be painted with suitable primer followed by Non-poisonous rubber paint.

**3. Guarantee**

The manufacturer shall furnish guarantee for two year against manufacturing defects, leakage etc., along with tender incorporating that in case of complaint they shall undertake satisfactory repair within 10 days free of coat.

**4. Inspection**

The quality inspection of water tanker shall be carried out by the Third Party inspection agency nominated by M.P. Agro.

**5. Tolerance :--**

± 2.5% Tolerance shall be allowed..

**6. Radium Triangular Reflection Board :--**

A triangular Plastic Radium Reflection Board should be fitted on the rear side of the tanker shell. Each side of the triangular board are 300 x 300 x 300 mm in length and 5 mm thickness.

**Note :-- If required minor deviation / amendment in specification may be done, after taking approval from M.P. Agro.**



**SCHEMATIC DIAGRAM OF M.S. WATER TANKER MOUNTED ON TWO WHEEL AGRICULTURE TRACTOR TRAILER CAPACITY 5000 Lit. WITH 900 x 16 & 9.00X20 NEW TYRE AND TUBE WITH FIRE FIGHTING PUMP & ACCESSORIES**

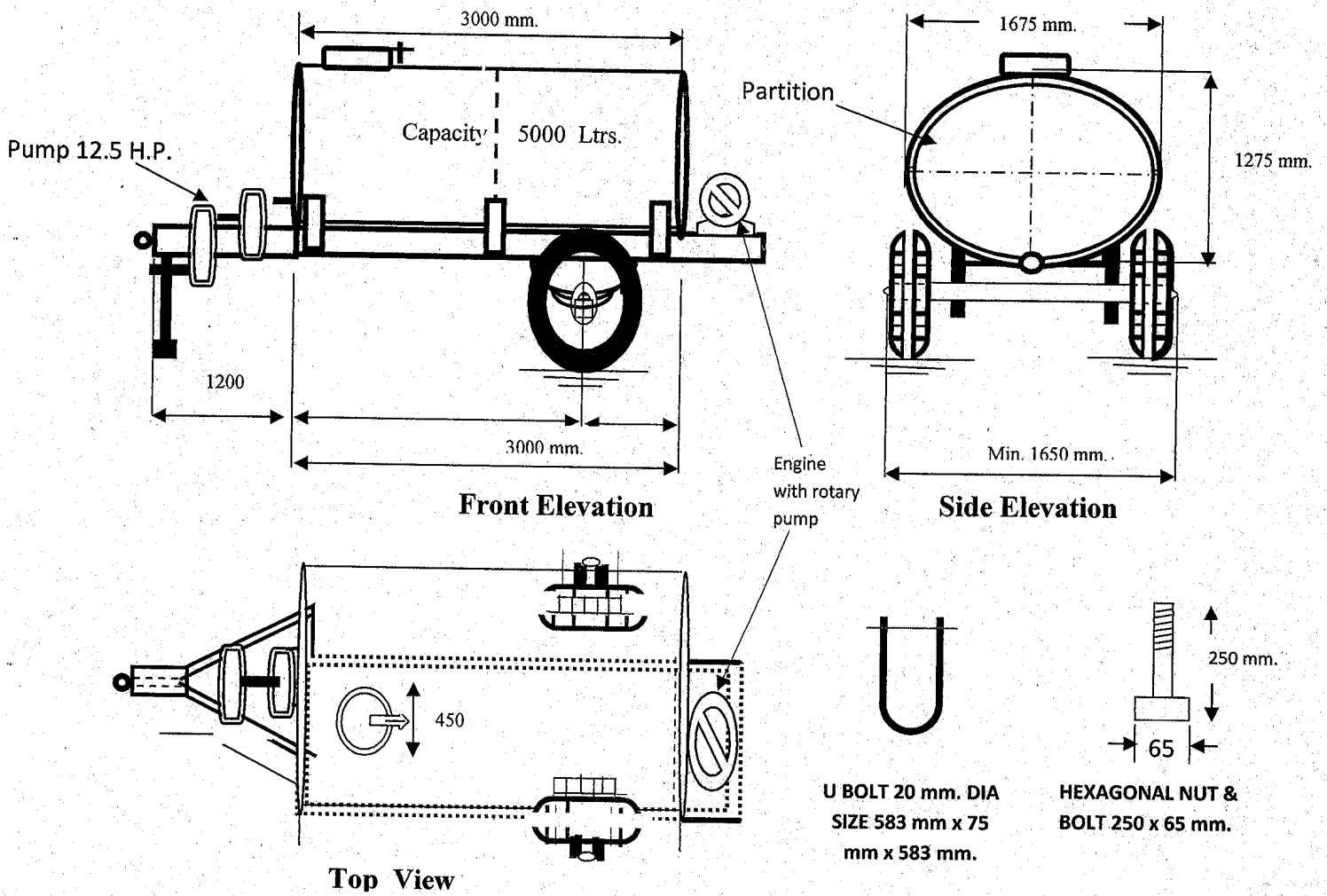

1. TYRES TUBE & FLAP	:-	2 Nos.	900 x 16 or 900 x 20
2. WATER TANKER SHELL FOR 5000 Lit.	:-		1675 mm. x 1275 mm x 3000 mm.
3. WATER TANKER SHEET THICKNESS:-			3.0 mm. M.S. Sheet.
4. LAMINATED SPRING 19 LEAVES	:-	2 Set.	70 x 10 mm., Eye to Eye --- 900 mm.
5. CHASSIS FRAME :-			150 x 75 ISMC, L= 3400mm, W= 1000mm
6. AXLE	:-	1 No.	75mm (Solid bar)/85mm (hollow) x ≥1650mm
7. DRAW BAR	:-		150 x 75 ISMC, L= 1200 mm, W= 1000mm
8. U BOLT	:-	8 Nos.	18 mm. 7 x 3 x 7 Inch.
9. DRAW BAR HOOK	:-	1 No.	Diameter 40 mm., Length 250 mm.
10. STEEL HUB	:-	2 Nos.	20 mm. thick, 8 hole
11. DOUBLE PLATED RIM	:-	2 Nos.	5 mm. thick.
12. BEARING	:-	2 Set.	32213 & 32216 No.
13. STEEL HANGER & SHACKLE	:-	4 Set	As per ISMC 150 x 75 mm.
14. NET WEIGHT OF FIRE FIGHTER :-			Up to 900 Kg. Approx
15. GROSS WEIGHT OF FIRE FIGHTER	:-		5950 Kg. Approx
16. MAN HOLE	:-		Collar W=450 mm, T= 4mm, Cover= 3mm
17. Fire Fighting Pump	:-	1 No.	12.5 H.P. centrifugal pump with PTO driven Or 6.5 H.P. Engine with rotary pump.

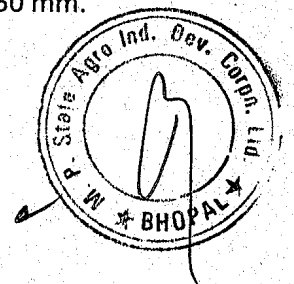

# Design of End Plate of Tanker

## Design of End Plate of Tanker

End plates of tanker shall be made of 3.0 mm. M.S. sheet in a dish end shape. Sheet should be in a single piece and bend on the periphery to give strength or flat end with inside stiffener angle of 3.0 mm all around on both end.

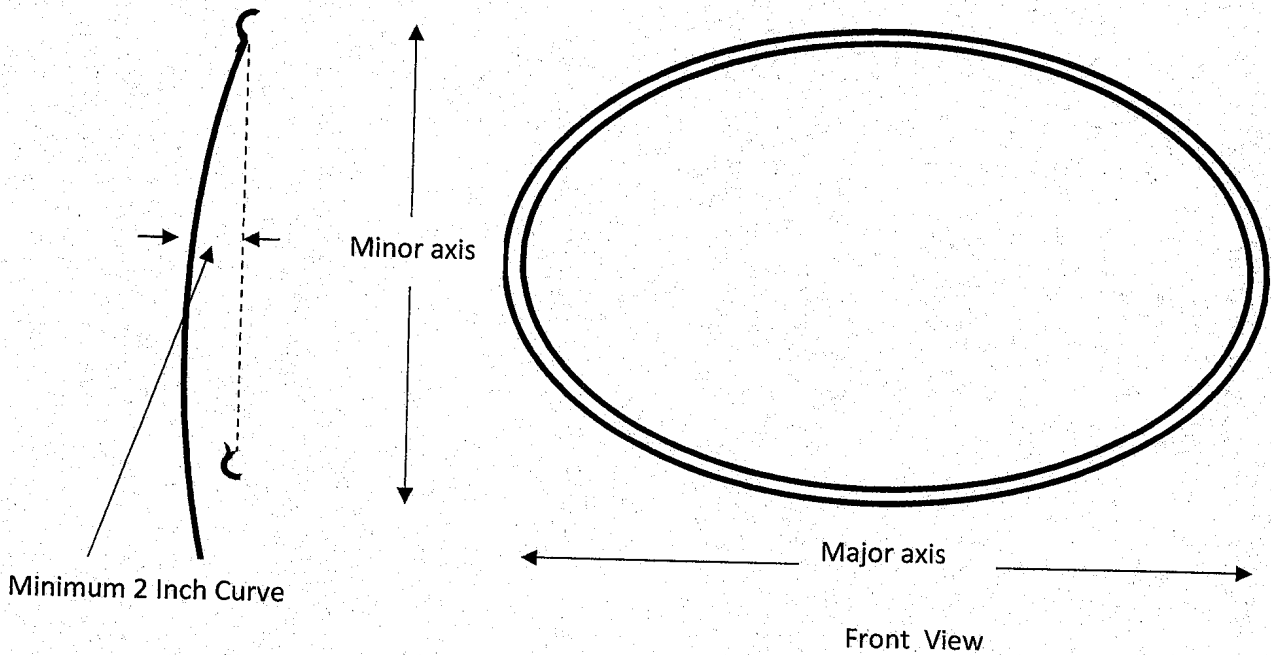

### Specifications :-

For 5000 lter.

Major axis ---- 1675 mm

Minor axis ---- 1275 mm.

Dish end curve ----- Min. 2 Inch.

Welding with shell ---- Lap joint.

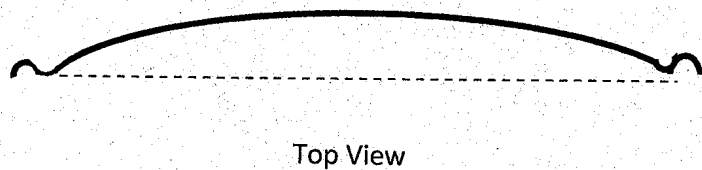

### Water distribution of Tank

#### Capacity Calculation

Capacity of the Tanker in Liters

$$\frac{\pi \times \text{Major Axis} \times \text{Minor Axis} \times \text{Length}}{4 \times 1000}$$

4 x 1000

Major & Minor Axis in Centimetres

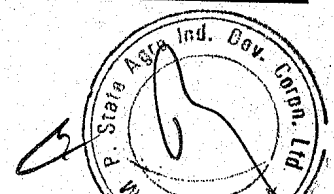
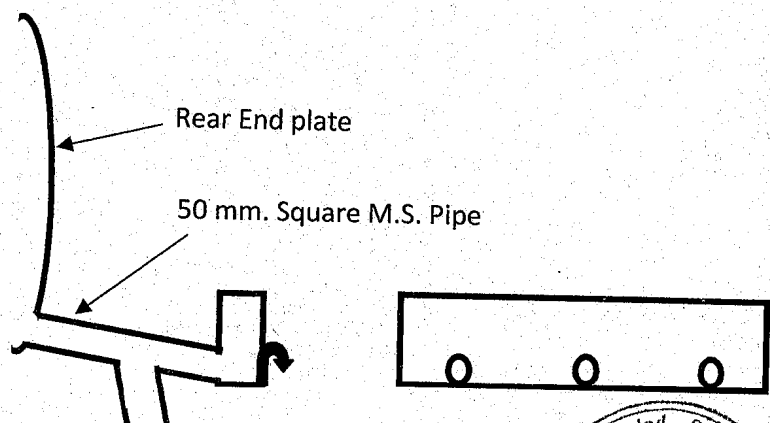

**G.I. WATER TANKER MOUNTED ON TWO WHEEL AGRICULTURE  
TRACTOR TRAILER CAPACITY 5000 Lit. & 5500 Lit. WITH 9.00X16 NEW  
TYRE AND TUBE**

**1. Chassis:**

The chassis shall be fabricated as per standard practice to mount the GI Tank. All the joint shall be welded properly as per standard practice. The chassis frame have two longitudinal members having ISMC 150 x 75 mm GI hot dipped channel section or Auto channel of size 150 x 75 mm having same specification and both having 5 cross member of the ISMC GI hot dipped channel 150 x 75 mm.

The overall approximate dimensions of various tanker trolley chassis shall be as under :--

S. No.	Approximate Capacity	Length	Width
1.	5000 Liter.	3450 mm.	1000 mm.
2.	5500 Liter.	3450 mm.	1000 mm.

**2. Draw Bar ( Chassis) :**

Draw Bar shall be Triangular v shape welded together at v joint and other side both member at main chassis channel section overlapped at least 300 mm. Draw Bar shall be made out of ISMC 150 x75 mm GI hot dipped channel section or GI hot dipped Auto channel of size 150 x 75 mm having same specification with eye hook made out of 40 mm. diameter MS round bar.

**3. Axle Assembly :**

Axle shall be made from solid square bar of 75 mm or 85 mm hollow square tube section with both the end machined and threaded and provided with iron hubs with 8 holes and minimum 20 mm. thick with hexagonal lock nut, fitted with twin taper roller bearing no. 32213 & 32216 provided with grease nipples for greasing the moving parts.

**4. Leaf Spring :**

Two set of leaf spring consisting of 19 leaves of size 70 x 10 mm. minimum 900 mm. long ( distance between two pin ) of alloy steel shall be provided. These leaf spring shall be fixed with frame by means of complete cast iron/Steel bracket assembly.

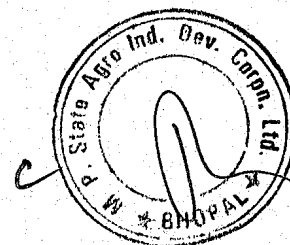

5. **Tyre Tubes & Wheel Assembly :**

Two number of New tyres 9.00 x 16 with tube & flap assembly of slandered make (MRF, Ceat, Hercules, JK, Apolo, Birla, Modi, Michigan, Goodyear, Bridgestone Yokohama etc) shall be provided with double plated rim 5 mm. thick with 8 No. of holes. **Remouled Tyres will not be allowed at any cost.**

6. **Shell of the Water Tanker :-**

The water tanker should have capacity of approximate 5000 lit. and 5500 liters, manufactured in semi elliptical shape. The tank shall be made out of 3.0 mm. thick sheet with minimum 50 gsm galvanized coating, and maximum number of plates are not more than 4 No., End plates of the tank shall be made of 2.50 mm thick sheet having minimum 50gsm galvanized coating with maximum in joint of two No. plate.

S. No.	Approximate Capacity	Major Axis	Minor Axis	Length
1.	5000 Liter.	1675 mm.	1275 mm.	3000 mm.
2.	5500 Liter.	1710 mm.	1310 mm.	3100 mm.

7. **Baffle Plate :-**

One baffle plate made of 3.00 mm. sheet with minimum 100 gsm galvanized coating shall be provided inside the tank over center reinforcement ( plus shape) shall be properly welded with the two angle in plus position touching major & minor axis peak points. The height of the baffle plate shall be just 20 c.m. above over half of the minor axis of the tank.

8. **Reinforcement or Grooving :-**

The tank shall be reinforcement from inside by welding three number of elliptica rings made of 40 x 40 x 6 mm. G.I. angle on both ends and one in between at suitable distance or making minimum three grooves or grooved galvanized strips on the entire circumference of the shell by press machine.

9. **Manhole:-**

One manhole with hinged cover shall be provided at the top of the tank . The cover of the tank shall be fabricated by 3.00 mm thick sheet with minimum 50 gsm galvanized coating. The collar of the cover and manhole shale be made out of 3.00 mm. strip with minimum 50gsm galvanized coating. Locking arrangement for cover shall also be provided. The man hole cover shall be such fabricated so that no foreign material may not enter in the tank.

The shell of the tank shall be rested on the chassis by means of six number of suitable fabricated shoes (box type bracket) of 4 mm. thick plate or molded having 2.5 mm. plates minimum 50 gsm galvanized coating brackets guide made out

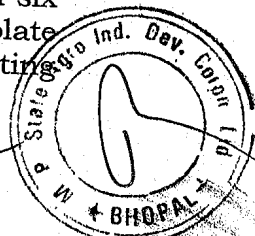

**10. Pump set stand :-**

Pump Set Stand shall be made of ISMC 150 x 75 mm hot dipped GI channel or Auto channel of size 150 x 75 mm having same specification hot dipped GI.

**11. General requirements of all types of Tanker:-**

**1. Outlet:-**

63 mm. NB class "A" GI nipple of 1 cm length (minimum) be provided at the rear of the tank along with required 75 mm cast Iron/steel ball valve/PVC Ball valve.

**2. Painting & Finishing**

The tanker should be spray painted, with priming coat of red oxide and two coat of synthetic enamel paint and colour as desired by consignee. Interior of the tank should be painted with suitable primer followed by Non-poisonous rubber paint.

**3. Guarantee**

The manufacturer shall furnish guarantee for two year against manufacturing defects, leakage etc., along with tender incorporating that in case of complaint they shall undertake satisfactory repair within 10 days free of coat.

**4. Inspection**

The quality inspection of water tanker shall be carried out by the Third Party inspection agency nominated by M.P. Agro.

**5. Tolerance :-**

± 2.5% Tolerance shall be allowed..

**6. Radium Triangular Reflection Board :-**

A triangular Plastic Radium Reflection Board should be fitted on the rear side of the tanker shell. Each side of the triangular board are 300 x 300 x 300 mm in length and 5 mm thickness

**Note :- If required minor deviation / amendment in specification may be done, after taking approval from M.P. Agro.**

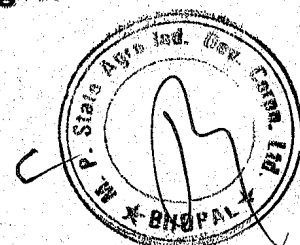

**G.I. WATER TANKER MOUNTED ON TWO WHEEL AGRICULTURE  
TRACTOR TRAILER CAPACITY 5000 Lit. & 5500 Lit. WITH 9.00X20  
NEW TYRE AND TUBE**

**1. Chassis:**

The chassis shall be fabricated as per standard practice to mount the GI Tank. All the joint shall be welded properly as per standard practice. The chassis frame have two longitudinal members having ISMC 150 x 75 mm GI hot dipped channel section or Auto channel of size 150 x 75 mm having same specification and both having 5 cross member of the ISMC GI hot dipped channel 150 x 75 mm.

The overall approximate dimensions of various tanker trolley chassis shall be as under :--

S. No.	Approximate Capacity	Length	Width
1.	5000 Liter.	3450 mm.	1000 mm.
2.	5500 Liter.	3450 mm.	1000mm.

**2. Draw Bar (Chassis) :**

Draw Bar shall be Triangular v shape welded together at v joint and other side both member at main chassis channel section overlapped at least 300 mm. Draw Bar shall be made out of ISMC 150 x75 mm GI hot dipped channel section or GI hot dipped Auto channel of size 150 x 75 mm having same specification with eye hook made out of 40 mm. diameter MS round bar.

**3. Axle Assembly :**

Axle shall be made from solid square bar of 75 mm or 85 mm hollow square tube section with both the end machined and threaded and provided with iron hubs with 8 holes and minimum 20 mm. thick with hexagonal lock nut, fitted with twin taper roller bearing no. 32213 & 32216 provided with grease nipples for greasing the moving parts.

**4. Leaf Spring :**

Two set of leaf spring consisting of 19 leaves of size 70 x 10 mm. minimum 900 mm. long ( distance between two pin ) of alloy steel shall be provided. These leaf spring shall be fixed with frame by means of complete cast iron/Steel bracket assembly.

**5. Tyre Tubes & Wheel Assembly :**

Two number of New tyres 9.00 x 20 with tube & flap assembly of slandered make (MRF, Ceat, Hercules, JK, Apolo, Birla, Modi, Michigan, Goodyear, Bridgestone Yokohama etc) shall be provided with double plated rim 5 mm. thick with 8 No. of holes. **Remoulded Tyres will not be allowed at any cost.**

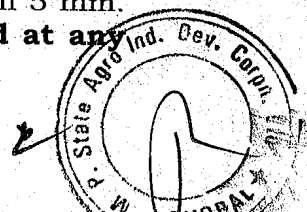

**6. Shell of the Water Tank :-**

The water tanker should have capacity of approximate 5000 lit. and 5500 liters, manufactured in semi elliptical shape. The tank shall be made out of 3.0 mm. thick steel sheet with minimum 50 gsm galvanized coating, and maximum number of plates are not more than 4 No., End plates of the tank shall be made of 3.0 mm thick steel sheet having minimum 50gsm galvanized coating with maximum in joint of two No. plate.

S. No.	Approximate Capacity	Major Axis	Minor Axis	Length
1.	5000 Liter.	1675 mm.	1275 mm.	3000 mm.
2.	5500 Liter.	1710 mm.	1310 mm.	3100 mm.

**7. Baffle Plate :-**

One baffle plate made of 3.00mm. with minimum 100 gsm galvanized coating shall be provided inside the tank over center reinforcement ( plus shape) shall be properly welded with the two angle in plus position touching major & minor axis peak points. The height of the baffle plate shall be just 20 c.m. above over half of the minor axis of the tank.

**8. Reinforcement or Grooving :-**

The tank shall be reinforcement from inside by welding three number of elliptica rings made of 40 x 40 x 6 mm. G.I. angle on both ends and one in between at suitable distance or making minimum three grooves or grooved G.I. strips on the entire circumference of the shell by press machine.

**9. Manhole:-**

One manhole with hinged cover shall be provided at the top of the tank . The cover of the tank shall be fabricated by 3.00 mm thick steel sheet having minimum 50 gsm galvanized coating. The collar of the cover and manhole shall be made out of 3.00 mm. steel strip with minimum 50 gsm galvanized coating. Locking arrangement for cover shall also be provided. The man hole cover shall be such fabricated so that no foreign material may not enter in the tank.

The shell of the tank shall be rested on the chassis by means of six number of suitable fabricated shoes (box type bracket) of 4 mm. thick plate or molded having 2.5 mm. plates. sheet brackets guide made out One ladder shall be made of 25 x 25 x 3mm I.S.A. or fabricated foot rest on the front end plates with handle.

**10. Pump set stand :-**

Pump Set Stand shall be made of ISMC 150 x 75 mm hot dipped GI channel or Auto channel of size 150 x 75 mm having same specification hot dipped GI.

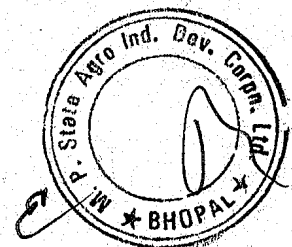

**General requirements of all types of Tanker:--**

**1. Outlet:--**

63 mm. NB class "A" GI nipple of 1 cm length (minimum) be provided at the rear of the tank along with required 75 mm cast Iron/steel ball valve/PVC Ball valve.

**2. Painting & Finishing:**

The tanker should be spray painted, with priming coat of red oxide and two coat of synthetic enamel paint and colour as desired by consignee. Interior of the tank should be painted with suitable primer followed by Non-poisonous rubber paint.

**3. Guarantee**

The manufacturer shall furnish guarantee for two year against manufacturing defects, leakage etc., along with tender incorporating that in case of complaint they shall undertake satisfactory repair within 10 days free of coat.

**4. Inspection:**

The quality inspection of water tanker shall be carried out by the Third Party inspection agency nominated by M.P. Agro.

**5. Tolerance:--**

± 2.5% Tolerance shall be allowed.

**6. Radium Triangular Reflection Board :--**

A triangular Plastic Radium Reflection Board should be fitted on the rear side of the tanker shell. Each side of the triangular board are 300 x 300 x 300 mm in length and 5 mm thickness

**Note :-- If required minor deviation / amendment in specification may be done, after taking approval from M.P. Agro.**

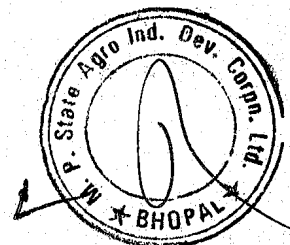

## Schematic Drawing of G.I. Water Tanker capacity 5000 lit. & 5500 Lit. with 900 x 16 & 900x 20 Tyre

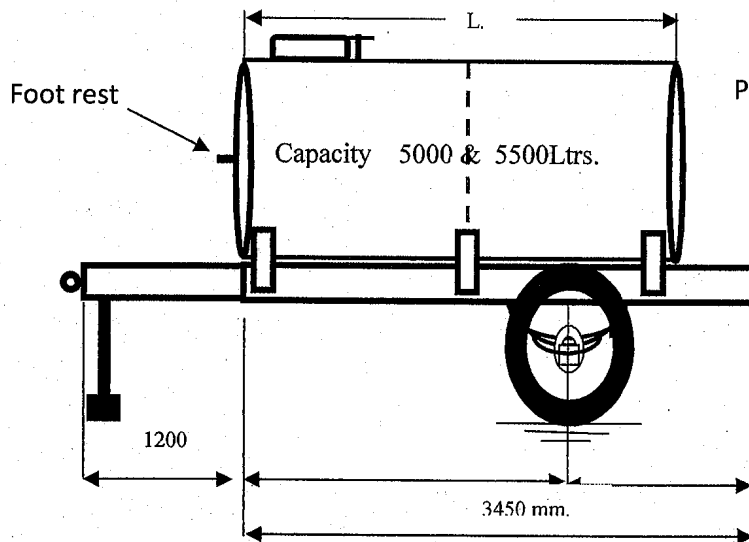

**Front Elevation**

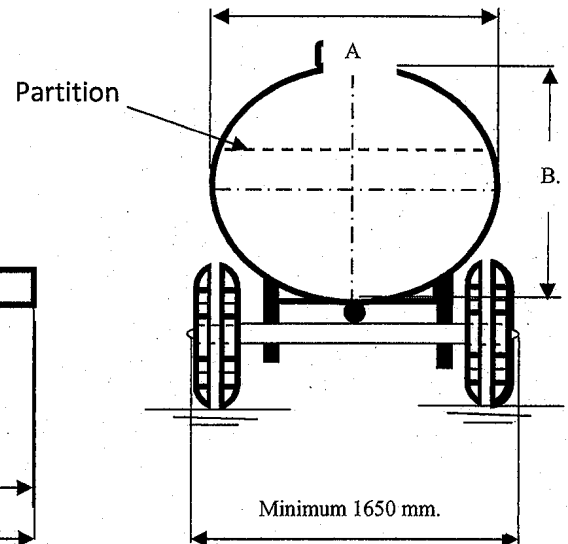

**Side Elevation**

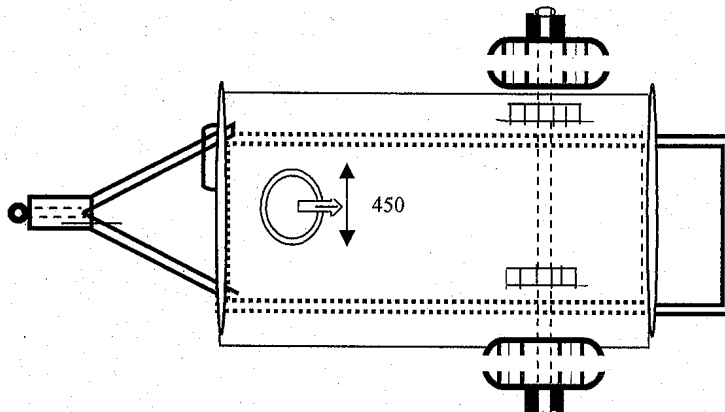

**Top View**

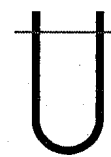

**U BOLT 20 mm. DIA  
SIZE 583 mm x 75  
mm x 583 mm.**

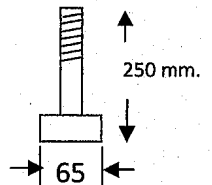

**HEXAGONAL NUT &  
BOLT 250 x 65 mm.**

1. TYRES TUBE & FLAP	:-	2 Nos.	900 x 16 or 900 x 20
2. WATER TANKER SHELL FOR 5000 Lit. :-			1675 mm. x 1275 mm x 3000 mm.
3. WATER TANKER SHELL FOR 5500 Lit. :-			1710 mm. x 1310 mm. x 3010 mm.
4. WATER TANKER SHEET THICKNESS:-			2.50 mm. G.I. Sheet having 50 gsm coat.
5. LAMINATED SPRING 19 LEAVES	:-	2 Set.	70 x 10 mm., Eye to Eye --- 900 mm.
6. CHASSIS FRAME :-			150 x 75 ISMC, L= 3400mm, W= 1000mm
7. AXLE	:-	1 Nos.	75mm (Solid bar)/85mm (hollow)x ≥1650mm
8. DRAW BAR	:-		150 x 75 ISMC, L= 1200 mm, W= 1000mm
9. U BOLT	:-	8 Nos.	18 mm.7 x 3 x 7 Inch.
10. DRAW BAR HOOK	:-	1 No	Diameter 40 mm., Length 250 mm.
11. STEEL HUB	:-	2 Nos	20 mm. thick, 8 hole
12 DOUBLE PLATED RIM	:-	2 Nos	5 mm. thick.
13 BEARING	:-	2 Set.	32213 & 32216 NO.
14 STEEL HANGER & SHACKLE	:-	4 Set	As per ISMC 150 x 75 mm.
15. NET WEIGHT 5000 & 5500 Lit	:-		Up to 850 Kg. Approx
16 GROSS WEIGHT 5000 & 5500 Lit.	:-		5850 Kg. & 6350 Kg. Approx
17. MAN HOLE	:-		Collar W=450 mm, T= 3mm, Cover= 3mm

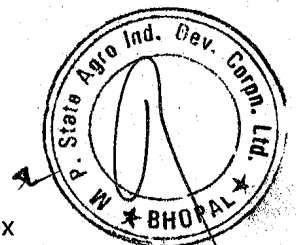

# Design of End Plate of Tanker

End plates of tanker shall be made of 3.0 mm. M.S. sheet in a dish end shape. Sheet should be in a single piece and bend on the periphery to give strength or flat end with inside stiffener angle of 3.0 mm all around on both end.

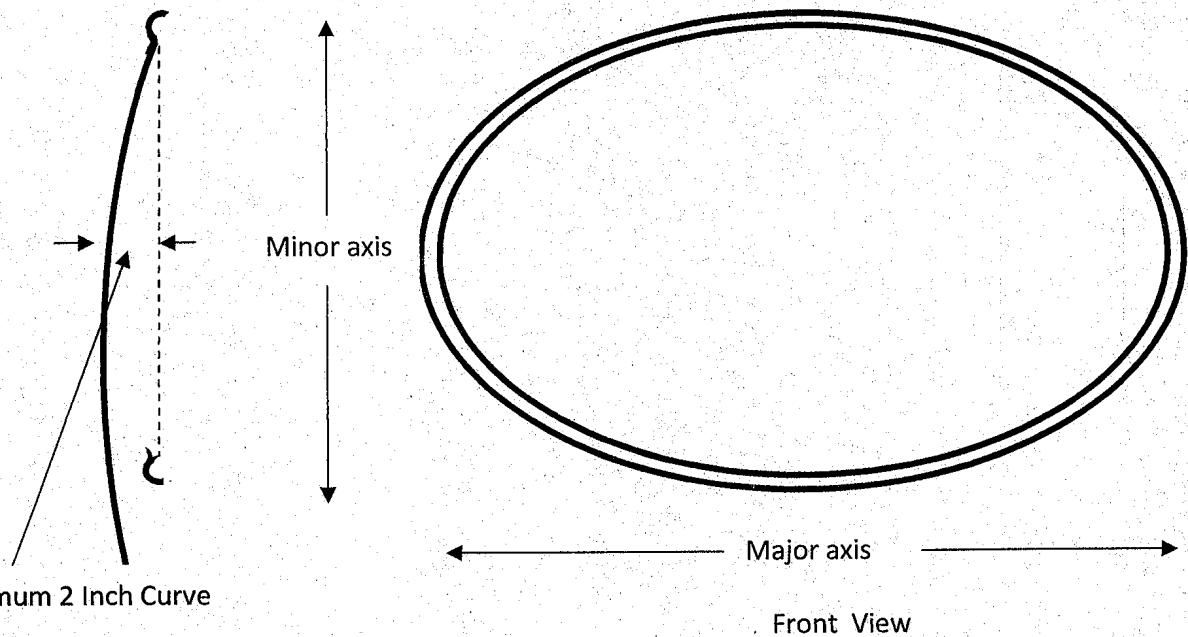

**Specifications :-**

**For 5000 iter.**

- Major axis ---- 1675 mm
- Minor axis ---- 1275 mm.
- Dish end curve ----- Min. 2 Inch.
- Welding with shell ---- Lap joint.

**For 5500 liter.**

- Major axis ---- 1710 mm.
- Minor axis ---- 1310 mm.
- Dish end curve ----- Min. 2 Inches.
- Welding with shell ---- Lap joint.

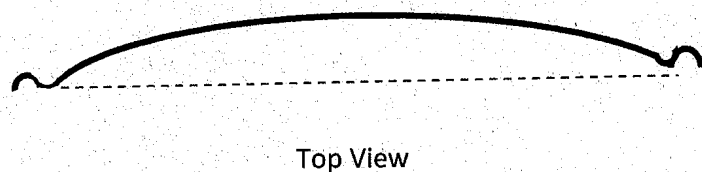

**Capacity Calculation**

Capacity of the Tanker in Liters

$$\pi \times \text{Major Axis} \times \text{Minor Axis} \times \text{Lengt}$$

$$4 \times 1000$$

Major Minor & Axis Length in Centimetres

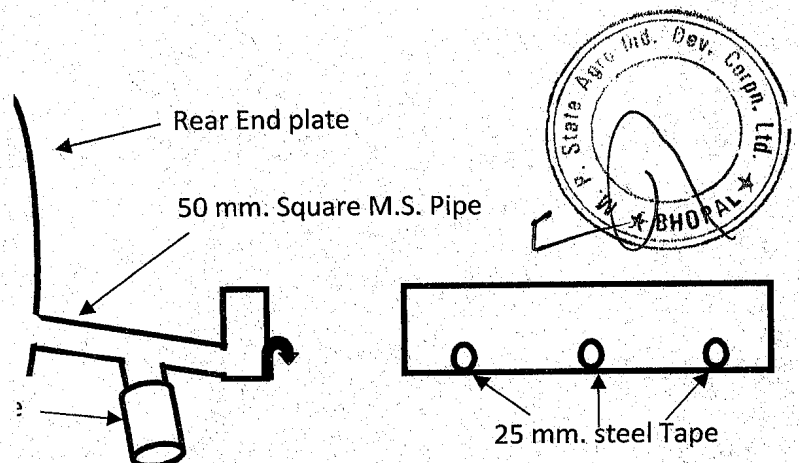

**G.I. WATER TANKER MOUNTED ON TWO WHEEL AGRICULTURE TRACTOR TRAILER CAPACITY 5000 Lit. WITH 900 x 16 & 9.00X20 NEW TYRE AND TUBE WITH FIRE FIGHTING PUMP & ACCESSORIES**

**1. Chassis:**

The chassis shall be fabricated as per standard practice to mount the GI Tank. All the joint shall be welded properly as per standard practice. The chassis frame have two longitudinal members having ISMC 150 x 75 mm GI hot dipped channel section or Auto channel of size 150 x 75 mm having same specification and both having 5 cross member of the ISMC GI hot dipped channel 150 x 75 mm.

The overall approximate dimensions of various tanker trolley chassis shall be as under :-

S. No.	Approximate Capacity	Length	Width
1.	5000 Liter.	3450 mm.	1000 mm.

**2. Draw Bar ( Chassis ) :**

Draw Bar shall be Triangular v shape welded together at v joint and other side both member at main chassis channel section overlapped at least 300 mm. Draw Bar shall be made out of ISMC 150 x75 mm GI hot dipped channel section or GI hot dipped Auto channel of size 150 x 75 mm having same specification with eye hook made out of 40 mm. diameter MS round bar.

**3. Axle Assembly :**

Axle shall be made from solid square bar of 75 mm or 85 mm hollow square tube section with both the end machined and threaded and provided with iron hubs with 8 holes and minimum 20 mm. thick with hexagonal lock nut, fitted with twin taper roller bearing no. 32213 & 32216 provided with grease nipples for greasing the moving parts.

**4. Leaf Spring :**

Two set of leaf spring consisting of 19 leaves of size 70 x 10 mm. minimum 900 mm. long ( distance between two pin ) of alloy steel shall be provided. These leaf spring shall be fixed with frame by means of complete cast iron/Steel bracket assembly.

**5. Tyre Tubes & Wheel Assembly :**

Two number of New tyres 900 x 16 or 9.00 x 20 with tube & flap assembly of slandered make (MRF, Ceat, Harculus, JK, Apolo, Birla, Modi, Michigan, Goodyear, Bridgestone Yokohama etc.) shall be provided with double plated rim 5 mm. thick with 8 No. of holes. **Remouled Tyres will not be allowed at any cost.**

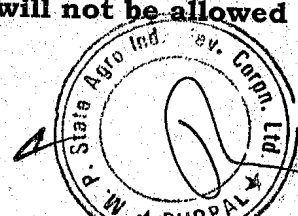

**6. Shell of the Water Tanker :-**

The water tanker should have capacity of approximate 5000 lit. and 5500 liters, manufactured in semi elliptical shape. The tank shall be made out of 3.00 mm. thick steel sheet having minimum 50 gsm galvanized coating over it , and maximum number of plates are not more than 4 No., End plates of the tank shall be made of 3.00 mm thick steel sheet having minimum 50 gsm galvanized coating with maximum in joint of two No. plate.

S. No.	Approximate Capacity	Major Axis	Minor Axis	Length
1.	5000 Liter.	1675 mm.	1275 mm.	3000 mm.

**7. Baffle Plate :-**

One baffle plate made of 3.00 mm. having minimum 100 gsm galvanized coating shall be provided inside the tank over center reinforcement ( plus shape) shall be properly welded with the two angle in plus position touching major & minor axis peak points. The height of the baffle plate shall be just 20 c.m. above over half of the minor axis of the tank.

**8. Reinforcement or Grooving :-**

The tank shall be reinforcement from inside by welding three number of elliptica rings made of 40 x 40 x 6 mm. M.S. angle on both ends and one in between at suitable distance or making minimum three grooves or grooved strips on the entire circumference of the shell by press machine.

**9. Manhole:-**

One manhole with hinged cover shall be provided at the top of the tank . The cover of the tank shall be fabricated by 3.00 mm thick M.S. sheet. The collar of the cover and manhole shall be made out of 4.00 mm. MS strip. Locking arrangement for cover shall also be provided. The man hole cover shall be such fabricated so that no foreign material may not enter in the tank.

The shell of the tank shall be rested on the chassis by means of six number of suitable fabricated shoes ( box type bracket) of 4 mm. thick plate or molded having 2.5 m. steel sheet brackets guide made out One ladder shall be made of 25 x 25 x 3 I.S.A. or fabricated foot rest on the front end plates with handle.

**10. Pump set stand :-**

Pump Set Stand shall be made of ISMC 150 x 75 mm hot dipped GI channel or Auto channel of size 150 x 75 mm having same specification hot dipped GI.

**11. Fire Fighter :-**

Medium duty centrifugal pump assembly is driven by pulley ( Increased velocity ratio from 1 to 3 ) drive & connected with P.T.O. shaft of the tractor by means of propeller shaft & universal joint assembly.

Size range :- 65 mm x 50 mm.

R.P.M. :- 1400 to 1500

Req. H.P. :- 12.5 H.P.

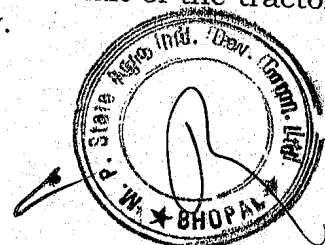

Out let of the pump is attached with 50 mm. cotton flexible fabric delivery pipe of 15 mtr. Length followed with Aluminum Nozzle assembly along with GI Box (with reel system) in which the delivery pipe stored properly. Inlet or suction pipe having 50/63 mm. diameter flexible green hose pipe of 6 mtr. Length followed 50/63 mm. PVC foot valve.

OR

6.5 H.P. engine is fitted on the rear side of chassis with Centrifugal pump with Out let of the pump is attached with 50 mm. cotton flexible fabric delivery pipe of 15 mtr. Length followed with Aluminum Nozzle assembly along with GI Box (with reel system) in which the delivery pipe stored properly. Inlet or suction pipe having 50/63 mm. diameter flexible green hose pipe of 6 mtr. Length followed 50/63 mm. PVC foot valve.

**11. General requirements of all types of Tanker:--**

**1. Outlet:--**

63 mm. NB class "A" GI nipple of 1 cm length (minimum) be provided at the rear of the tank along with required 75 mm cast Iron/steel ball valve/PVC Ball valve.

**2. Painting & Finishing:**

The tanker should be spray painted, with priming coat of red oxide and two coat of synthetic enamel paint and colour as desired by consignee. Interior of the tank should be painted with suitable primer followed by Non-poisonous rubber paint.

**3. Guarantee:**

The manufacturer shall furnish guarantee for one year against manufacturing defects, leakage etc., along with tender incorporating that in case of complaint they shall undertake satisfactory repair within 10 days free of cost.

**4. Inspection**

The quality inspection of water tanker shall be carried out by the Third Party inspection agency nominated by M.P. Agro.

**5. Tolerance**

± 2.5% Tolerance shall be allowed

**6. Radium Triangular Reflection Board :--**

A triangular Plastic Radium Reflection Board should be fitted on the rear side of the tanker shell. Each side of the triangular board are 300 x 300 x 300 mm in length and 5 mm thickness

**Note :-- If required minor deviation / amendment in specification may be done, after taking approval from M.P. Agro.**



**SCHEMATIC DIAGRAM OF G.I. WATER TANKER MOUNTED ON TWO WHEEL AGRICULTURE TRACTOR TRAILER CAPACITY 5000 Lit. WITH 900 x 16 & 9.00X20 NEW TYRE AND TUBE WITH FIRE FIGHTING PUMP & ACCESSORIES**

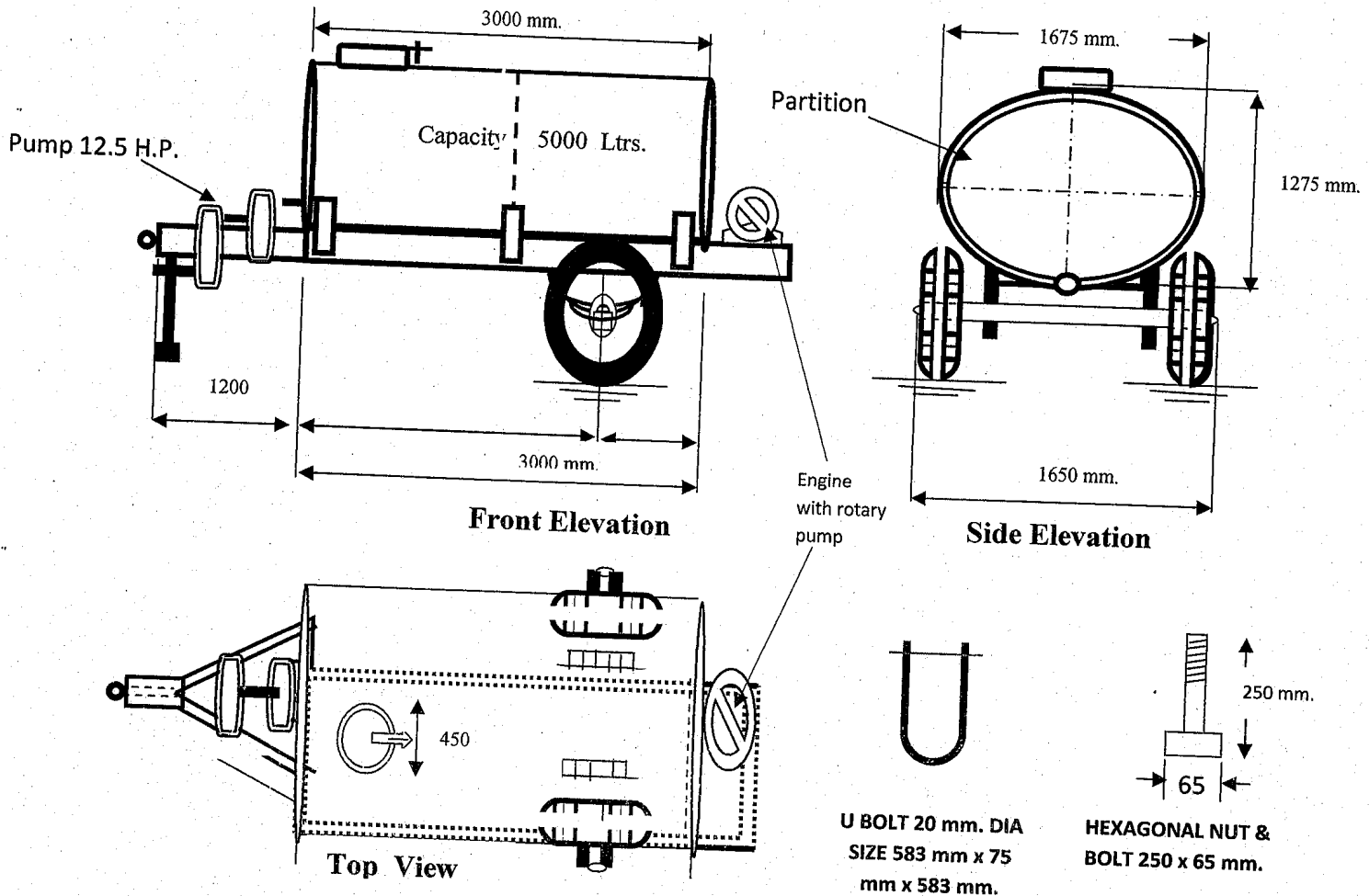

1. TYRES TUBE & FLAP	:-	2 No.	900 x 16 or 900 x 20
2. WATER TANKER SHELL FOR 5000 Lit.	:-		1675 mm. x 1275 mm x 3000 mm.
3. WATER TANKER SHEET THICKNESS	:-		2.50 mm. steel Sheet 50 gsm zinc coating.
4. LAMINATED SPRING 19 LEAVES	:-	2 Set.	70 x 10 mm., Eye to Eye --- 900 mm.
5. CHASSIS FRAME	:-		150 x 75 ISMC, L= 3400mm, W= 1000mm
6. AXLE	:-	1 No.	75mm (Solid bar)/85mm (hollow) x ≥1650mm
7. DRAW BAR	:-		150 x 75 ISMC, L= 1200 mm, W= 1000mm
8. U BOLT	:-	8 No.	18 mm. 7 x 3 x 7 Inch.
9. DRAW BAR HOOK	:-	1 NO	Diameter 40 mm., Length 250 mm.
10. STEEL HUB	:-	2 NO	20 mm. thick, 8 hole
11. DOUBLE PLATED RIM	:-	2 NO	5 mm. thick.
12. BEARING	:-	2 Set.	32213 & 32216 NO.
13. STEEL HANGER & SHACKLE	:-	4 Set	As per ISMC 150 x 75 mm.
14. NET WEIGHT of FIRE FIGHTER	:-		Up to 900 Kg. Approx
15. GROSS WEIGHT FIRE FIGHTER	:-		5950 Kg. Approx
16. MAN HOLE G.I.	:-		Collar W=450 mm, T= 3mm, Cover= 3mm
17. Fire Fighting Pump	:-	1 No.	12.5 H.P. centrifugal pump with PTO driven Or 6.5 H.P. Engine with rotary pump.

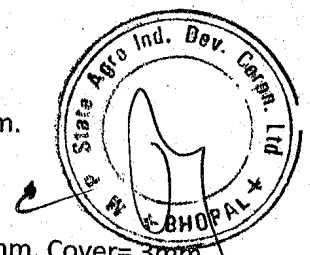

# Design of End Plate of Tanker

End plates of tanker shall be made of 3.0 mm. G.I. sheet in a dish end shape. Sheet should be in a single piece and bend on the periphery to give strength or flat end with inside stiffener angle of 3.0 mm all around on both end.

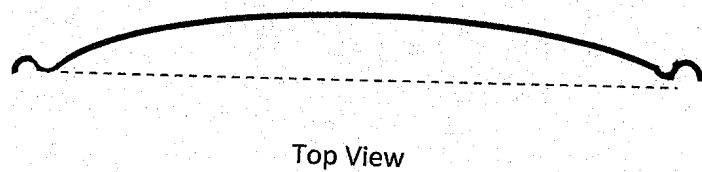
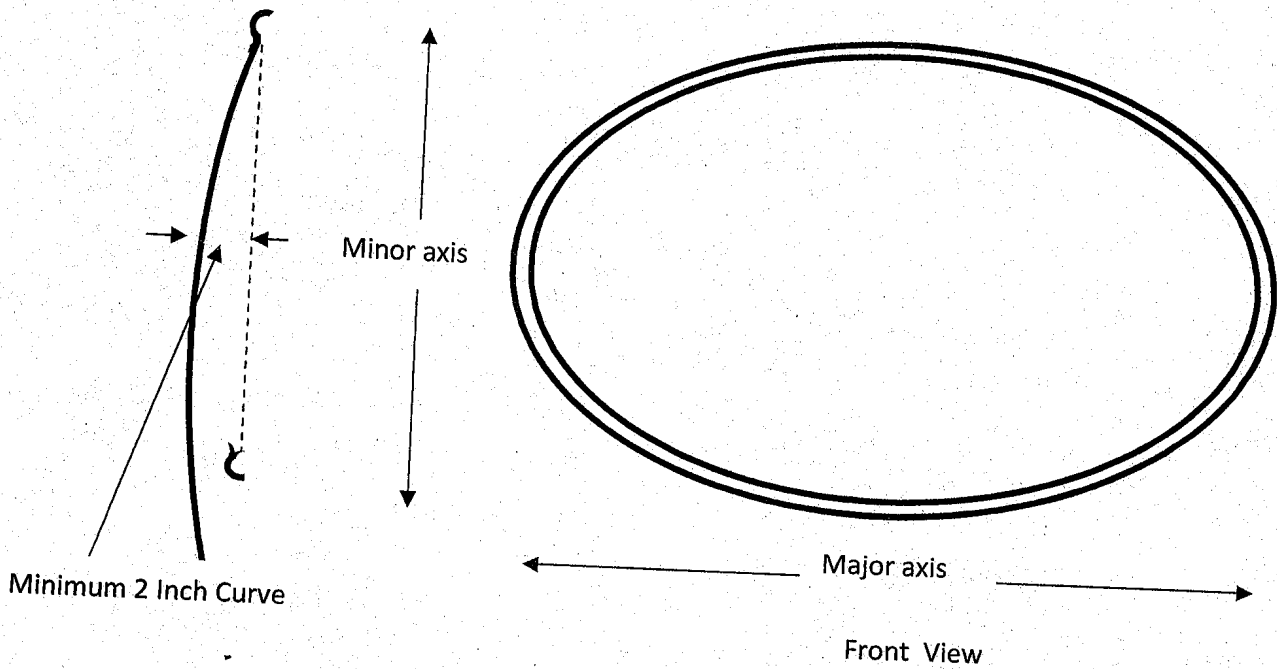

## Specifications :-

**For 5000 lter.**

Major axis ---- 1675 mm

Minor axis ---- 1275 mm.

Dish end curve ---- Min. 2 Inch.

Welding with shell ---- Lap joint.

## Capacity Calculation

Capacity of the Tanker in Liters

$$\frac{\pi \times \text{Major Axis} \times \text{Minor Axis} \times \text{Length}}{4 \times 1000}$$

4 x 1000

Major & Minor Axis in Centimetres

